

# User Manual

## UHF5 Pro/UHF10 Pro Reader

Date: October 2020

Doc Version: 1.0

English

Thank you for choosing our product. Please read the instructions carefully before operation. Follow these instructions to ensure that the product is functioning properly. The images shown in this manual are for illustrative purposes only.



For further details, please visit our Company's website [www.zkteco.com](http://www.zkteco.com).

## Copyright © 2020 ZKTECO CO., LTD. All rights reserved.

Without the prior written consent of ZKTeco, no portion of this manual can be copied or forwarded in any way or form. All parts of this manual belong to ZKTeco and its subsidiaries (hereinafter the "Company" or "ZKTeco").

## Trademark

**ZKTeco** is a registered trademark of ZKTeco. Other trademarks involved in this manual are owned by their respective owners.

## Disclaimer

This manual contains information on the operation and maintenance of the ZKTeco equipment. The copyright in all the documents, drawings, etc. in relation to the ZKTeco supplied equipment vests in and is the property of ZKTeco. The contents hereof should not be used or shared by the receiver with any third party without express written permission of ZKTeco.

The contents of this manual must be read as a whole before starting the operation and maintenance of the supplied equipment. If any of the content(s) of the manual seems unclear or incomplete, please contact ZKTeco before starting the operation and maintenance of the said equipment.

It is an essential pre-requisite for the satisfactory operation and maintenance that the operating and maintenance personnel are fully familiar with the design and that the said personnel have received thorough training in operating and maintaining the machine/unit/equipment. It is further essential for the safe operation of the machine/unit/equipment that personnel has read, understood and followed the safety instructions contained in the manual.

In case of any conflict between terms and conditions of this manual and the

contract specifications, drawings, instruction sheets or any other contract-related documents, the contract conditions/documents shall prevail. The contract specific conditions/documents shall apply in priority.

ZKTeco offers no warranty, guarantee or representation regarding the completeness of any information contained in this manual or any of the amendments made thereto. ZKTeco does not extend the warranty of any kind, including, without limitation, any warranty of design, merchantability or fitness for a particular purpose.

ZKTeco does not assume responsibility for any errors or omissions in the information or documents which are referenced by or linked to this manual. The entire risk as to the results and performance obtained from using the information is assumed by the user.

ZKTeco in no event shall be liable to the user or any third party for any incidental, consequential, indirect, special, or exemplary damages, including, without limitation, loss of business, loss of profits, business interruption, loss of business information or any pecuniary loss, arising out of, in connection with, or relating to the use of the information contained in or referenced by this manual, even if ZKTeco has been advised of the possibility of such damages.

This manual and the information contained therein may include technical, other inaccuracies or typographical errors. ZKTeco periodically changes the information herein which will be incorporated into new additions/amendments to the manual. ZKTeco reserves the right to add, delete, amend or modify the information contained in the manual from time to time in the form of circulars, letters, notes, etc. for better operation and safety of the machine/unit/equipment. The said additions or amendments are meant for improvement /better operations of the machine/unit/equipment and such amendments shall not give any right to claim any compensation or

damages under any circumstances.

ZKTeco shall in no way be responsible (i) in case the machine/unit/equipment malfunctions due to any non-compliance of the instructions contained in this manual (ii) in case of operation of the machine/unit/equipment beyond the rate limits (iii) in case of operation of the machine and equipment in conditions different from the prescribed conditions of the manual.

The product will be updated from time to time without prior notice. The latest operation procedures and relevant documents are available on <http://www.zkteco.com>

If there is any issue related to the product, please contact us.

## ZKTeco Headquarters

**Address**      ZKTeco Industrial Park, No. 26, 188 Industrial Road,  
Tangxia Town, Dongguan, China.

**Phone**        +86 769 - 82109991

**Fax**            +86 755 - 89602394

For business related queries, please write to us at: [sales@zkteco.com](mailto:sales@zkteco.com).

To know more about our global branches, visit [www.zkteco.com](http://www.zkteco.com).

## About the Company

ZKTeco is one of the world's largest manufacturer of RFID and Biometric (Fingerprint, Facial, Finger-vein) readers. Product offerings include Access Control readers and panels, Near & Far-range Facial Recognition Cameras, Elevator/floor access controllers, Turnstiles, License Plate Recognition (LPR) gate controllers and Consumer products including battery-operated fingerprint and face-reader Door Locks. Our security solutions are multi-lingual and localized in over 18 different languages. At the ZKTeco state-of-the-art 700,000 square foot ISO9001-certified manufacturing facility, we control manufacturing, product design, component assembly, and logistics/shipping, all under one roof.

The founders of ZKTeco have been determined for independent research and development of biometric verification procedures and the productization of biometric verification SDK, which was initially widely applied in PC security and identity authentication fields. With the continuous enhancement of the development and plenty of market applications, the team has gradually constructed an identity authentication ecosystem and smart security ecosystem, which are based on biometric verification techniques. With years of experience in the industrialization of biometric verifications, ZKTeco was officially established in 2007 and now has been one of the globally leading enterprises in the biometric verification industry owning various patents and being selected as the National High-tech Enterprise for 6 consecutive years. Its products are protected by intellectual property rights.

## About the Manual

This manual introduces the operations of UHF5 Pro/UHF10 Pro Reader.

All figures displayed are for illustration purposes only. Figures in this manual may not be exactly consistent with the actual products.

## Table of Contents

- 1 OVERVIEW.....6**
- 2 SIDE VIEW & WIRING.....7**
- 3 SPECIFICATIONS .....8**
- 4 DIMENSIONS .....9**
- 5 SOFTWARE CONFIGURATION.....10**
  - 5.1 INTRODUCTION ..... 10
    - 5.1.1 MAIN INTERFACE ..... 10
    - 5.1.2 RS485 SETTING INTERFACE..... 14
    - 5.1.3 SYSTEM SETTINGS..... 16
- 6 ACCESS CONTROLLER CONNECTION .....18**
- 7 INSTALLATION PROCEDURE.....19**
- 8 WIRING DIAGRAM.....22**
- 9 FAQ .....22**

## 1 Overview

UHF5 Pro/UHF10 Pro is the ZKTeco's third generation UHF reader which has a more stable performance, longer reading distance and faster recognition speed. It is equipped with a passive UHF card, which could be widely used in Vehicle management and Personnel management applications. The product also meets the CE, FCC technology requirements, and yet to obtain the CE, FCC, and other security certifications.



**UHF5 Pro**



**UHF10 Pro**

### **Antenna operating frequency**

- European Standard: 865MHz-868MHz
- American Standard: 902MHz-906MHz (optional)

### **Card reading range**

- UHF5F / E hand-held test up to 10m, driving car test around 4m
- UHF10F / E hand-held test up to 20m, driving car test around 8m

## 2 Side View & Wiring

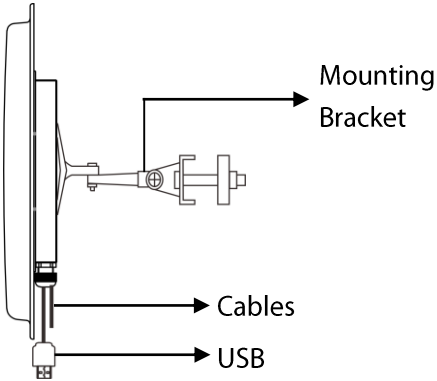

No.	Colour	Connection
1	Red	DC +12V
2	Black	GND
3	Green	Wiegand D0
4	White	Wiegand D1
5	Purple	Trigger Point
6	Gray	GND
7	USB	Connect to PC
8	Brown	RS485+
9	Orange	RS485-



### 3 Specifications

Model	UHF5E /F Pro	UHF10E/F Pro
<b>Reading Distance</b>	2 to 8 meters (Hand-held test) Actual scenario test is around 4m	10 to 20meters (Hand-held test) Actual scenario test is around 8m
<b>Antenna Gain</b>	9dBi	12dBi
<b>Dimension</b>	308.5*308.5*67.5 mm	445*445*67.5 mm
<b>Weight</b>	1.8kg	3kg
<b>Power</b>	1.2 to 4.2 W	1.2 to 4.5 W
<b>Frequency</b>	E: 865MHz to 868MHz F: 902MHz to 906MHz (supports adjustment)	
<b>Communication interface</b>	Wiegand; RS485; USB Configuration parameters (Wiegand, RS485 requires one of the two options)	
<b>Interface Protocol</b>	EPC global UHF Class 1 Gen 2 / ISO 18000-6C	
<b>Working Mode</b>	Read Always (Default) & Read by Trigger	
<b>Output Power</b>	19dBm to 30dBm	
<b>Protection Class</b>	IP66	
<b>Working Voltage</b>	DC 9 to15V	
<b>Working Temperature and Humidity</b>	-20°C to 65°C, <85%	
<b>Storage Temperature and Humidity</b>	-20°C to 80°C, <85%	
<b>RS485 Communication</b>	Optional baud rate (9600, 19200, 38400, 57600, 115200). The default is 115200	

# 4 Dimensions

## UHF5 E/F Pro:

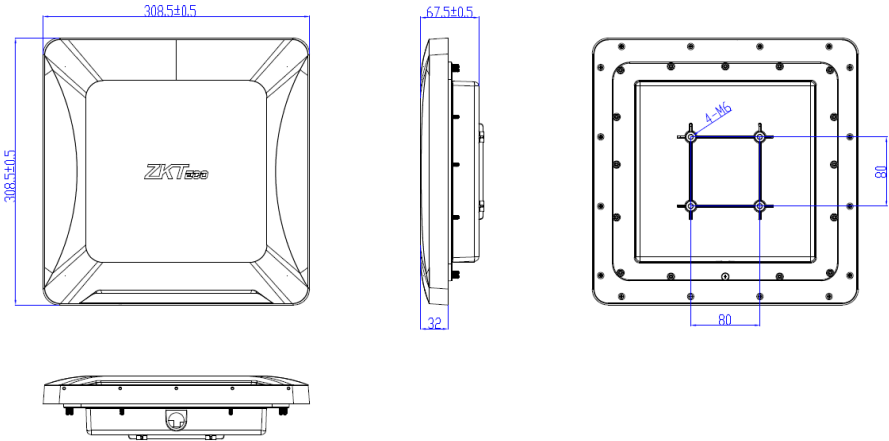

## UHF 10E/F Pro:

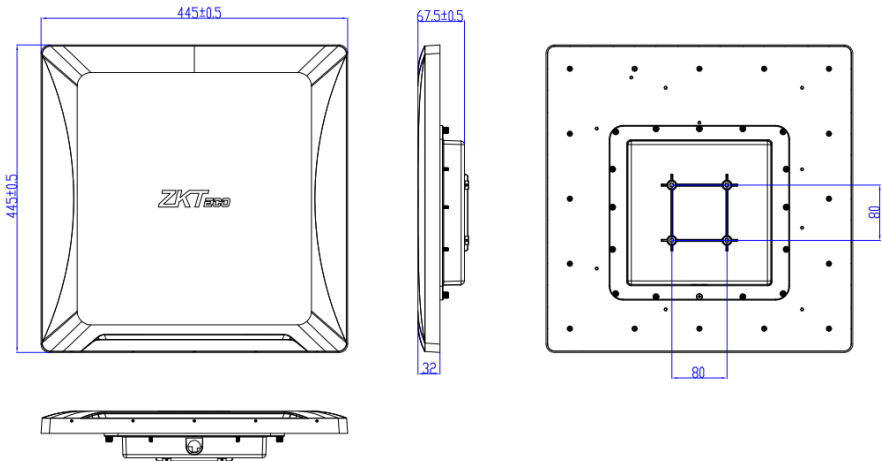

# 5 Software Configuration

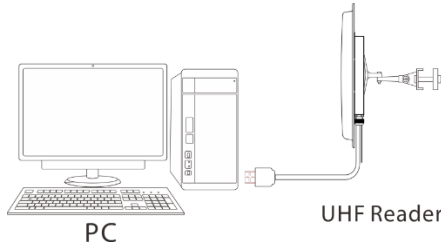

## 5.1 Introduction

### 5.1.1 Main Interface

Take the operation of the American standard reader as an example:

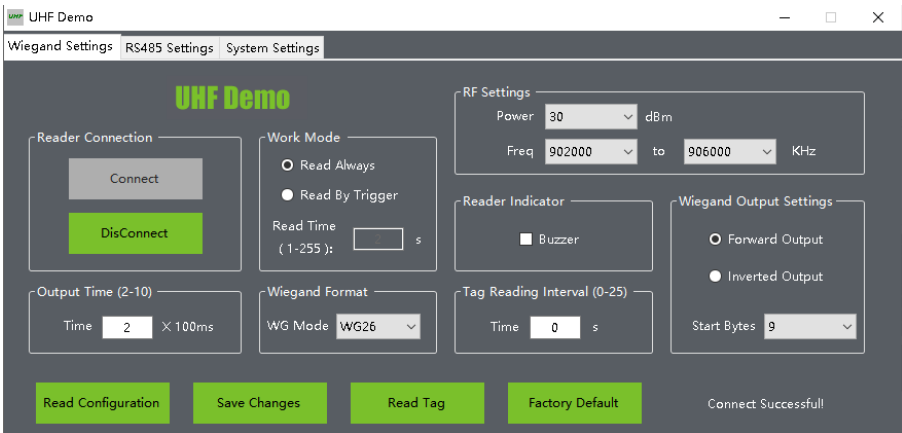

### **Reader Connection**

Click **Connect** to connect the Reader, and click **Disconnect** to disconnect the Reader.

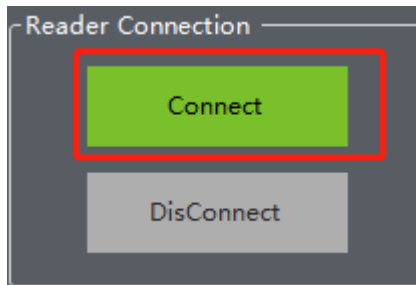

### **Work Mode Configuration**

Click **Read Always** to make the Reader always in the read status. Click **Read by Trigger** to enable the reader to read only after it is triggered.

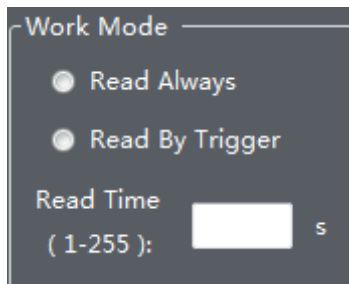

### **RF Settings**

The RF Settings helps to set the Power and Frequency values.

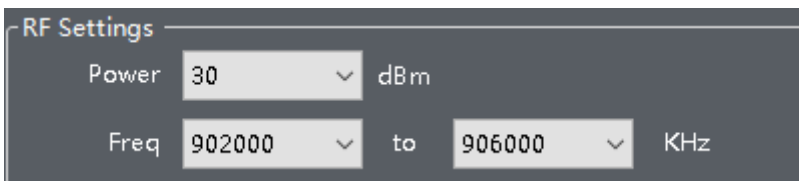

**Buzzer**

Select the **Buzzer** check box to enable the Buzzer.

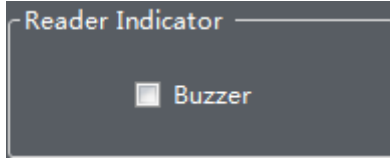

**Wiegand Output Setting**

The Wiegand Output Settings consist of Forward Output and Inverted Output. Click **Forward Output** to read the card number in the partition in the progressive order, and click **Inverted Output** to read out the card number in the partition in the reverse order (customers need not set).

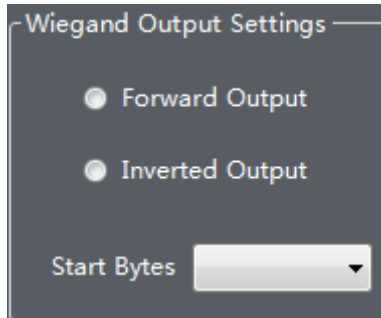

**Output Duration Setting**

The time of continuous output signal of the reader can be set, and the maximum setting time is 1s.

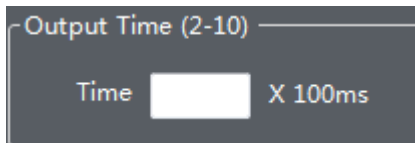

### **Wiegand Format Setting**

The default Wiegand format is WG26, and it can be set as WG34, WG42, WG50, WG58, WG66, WG74, WG82, WG90, WG98.

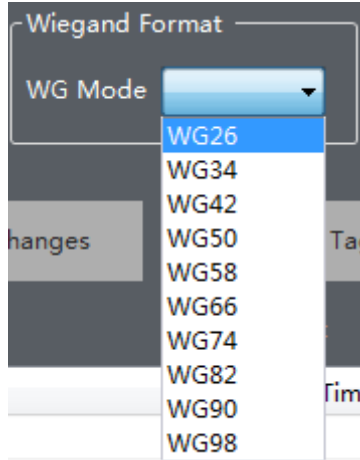

### **Card Reading Interval Setting**

You can set the card reading interval to prevent the repeated card reading.

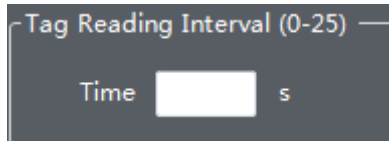

## 5.1.2 RS485 Setting Interface

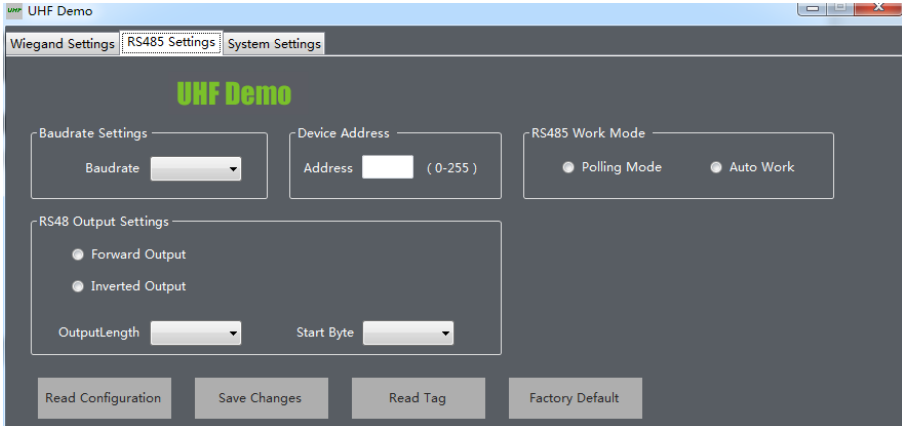

The controllers supported by default are inbio260 and inbio460.

### **Baud Rate Setting**

The default Baud rate is 96000 and it can be adjusted as per the requirements.

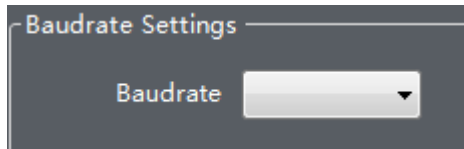

### **Device Address Setting**

The Device Address Setting is used to distinguish the readers which are installed in different locations.

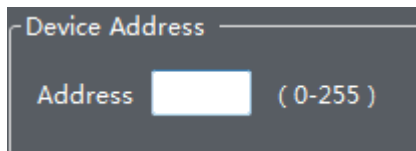

### **RS485 Working Mode**

Select **Polling Mode** to send a command to search for cards, and the reader will reply to the corresponding data after receiving the card search command. Select **Auto Work** to read the card and automatically upload the data to the Controller.

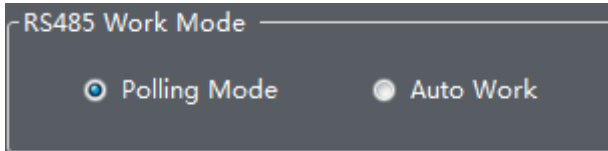

### **RS485 Output Mode**

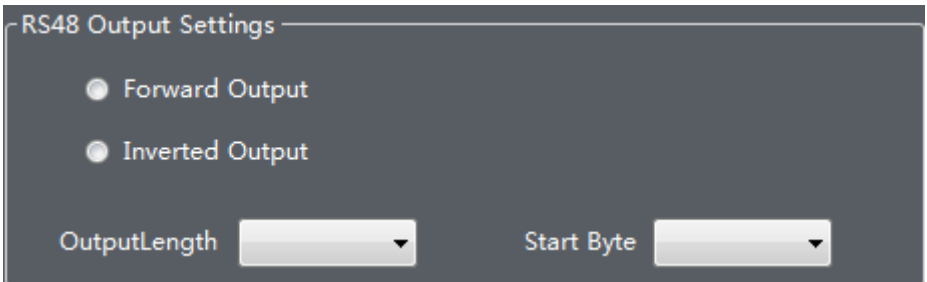

The RS485 Output Settings consist of Forward Output and Inverted Output. Click **Forward Output** to read the card number in the partition in the progressive order, and click **Inverted Output** to read out the card number in the partition in the reverse order.



### 5.1.3 System Settings

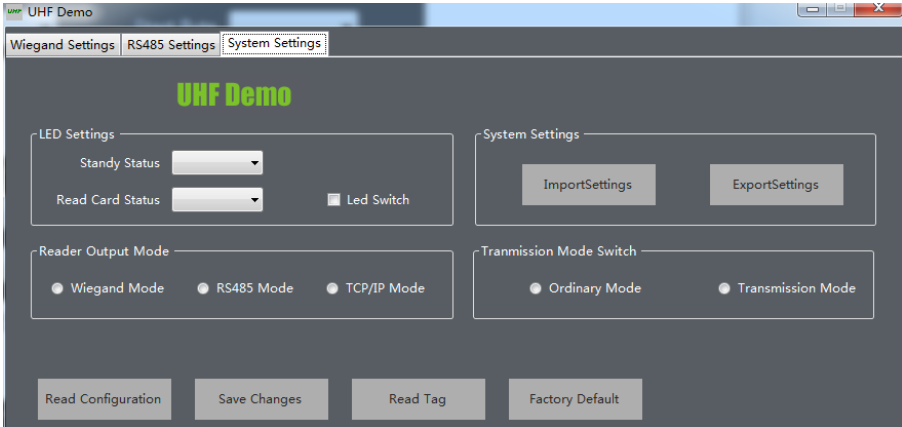

#### LED Light Setting

The LED indicator color can be set in the **Standby Status** and the **Read Card** Status. There are seven colors to choose.

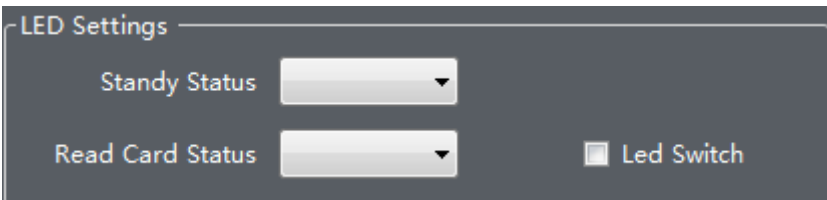

#### System Settings

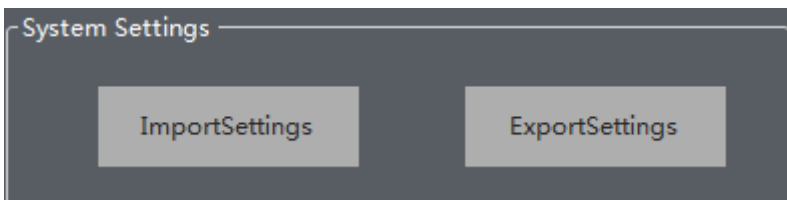

Set the location of the data import and export.

### **Card Reader Output**

There are 3 Card Reader output modes namely Wiegand Mode, RS485 mode and TCP/IP mode.

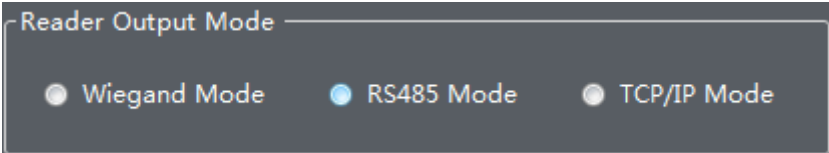

### **Language Settings**

Right click in the blank area of the Demo interface, a pop-up appears as shown below, click **Language Settings** to select the language.

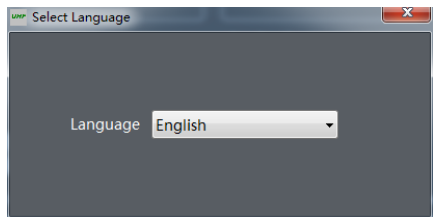
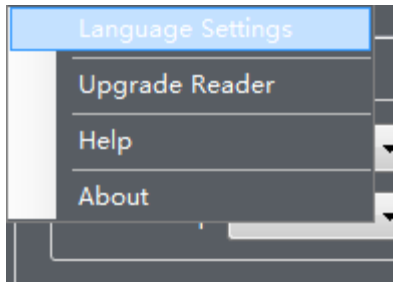

## 6 Access Controller Connection

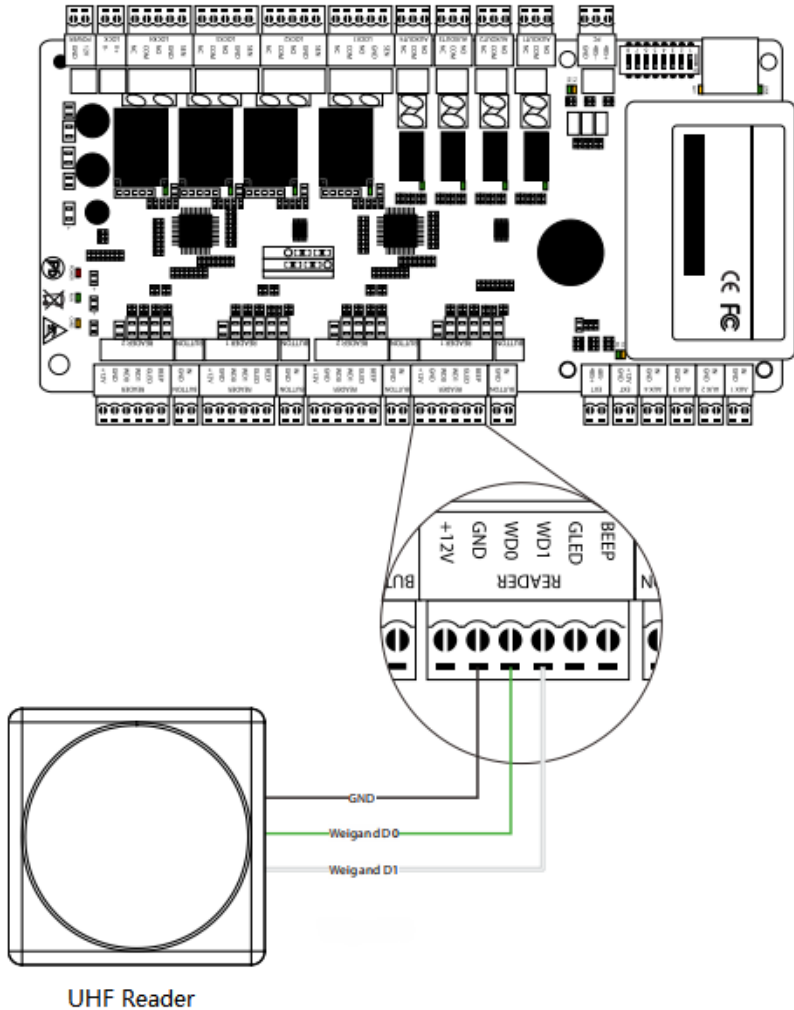

## 7 Installation Procedure

1. Please install the directional antenna with a lower elevation angle of  $60^{\circ}$  to  $75^{\circ}$  to suit the correct line of sight.

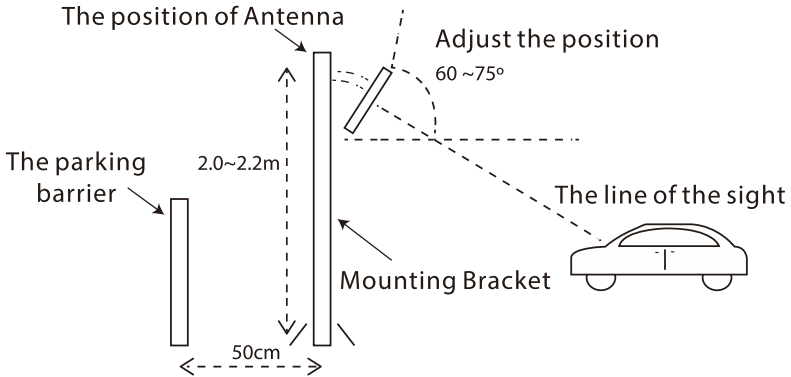

**Note:**

Please install the reader as shown in the above picture. The facing direction of the reader and the travel direction of the vehicle must be in a straight line. The distance between the reading head and the parking barrier must be maintained at 50cm or more.

2. Avoid installing the reader opposite to each other.

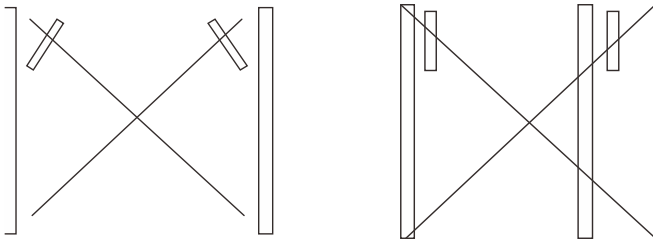

- 3. The position of the tag/card in the vehicle must be as follows:

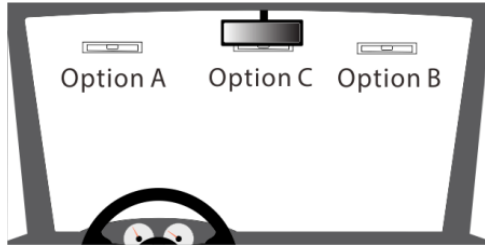



- 4. The reader detection distance may vary depending on climatic conditions such as rain, snow or wind.



- 5. The Reader should be away from any strong magnetic field while working.

**Recommended tags**

Type	Picture	Explanation
<p><b>UHF1-Tag1 card</b></p>		<p>Operating frequency: 840 to 960MHz                      Data Storage: 32-bit TID, 64-bit Unique TID, 96-bit EPC, 512-bit User.                      Supported Protocol: EPC global class 1 Gen2 / ISO18000-6C                      Product size: 85.6x54.0x0.8mm</p>
<p><b>UHF Parking Tag Parking lot label</b></p>		<p>Operating frequency: 840 to 960MHz                      Data Storage: 32-bit TID, 64-bit Unique TID, 96-bit EPC, 512-bit User, etc.                      Support Protocol: EPC global class 1 Gen2 / ISO18000-6C                      Product size: 100.0x23.2x0.4mm</p>

## 8 Wiring Diagram

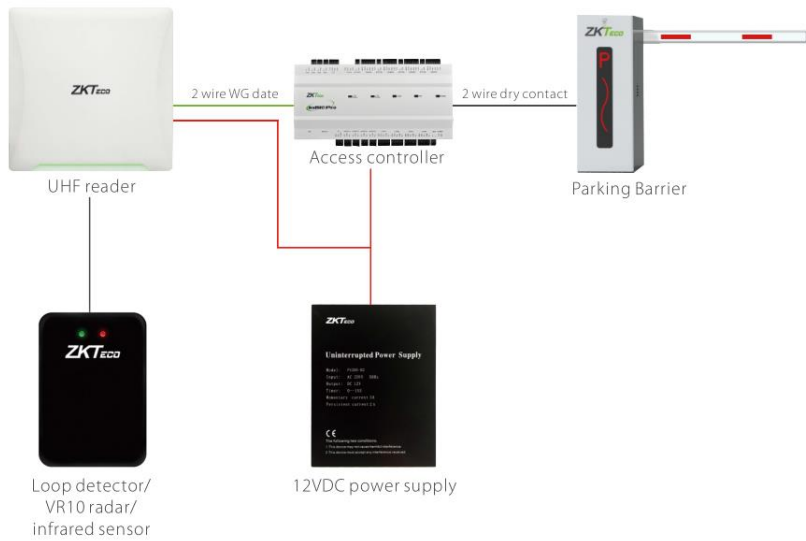

## 9 FAQ

### ➤ What to do if the recognition distance of the reader is too close?

Try the following possibilities:

- Connect the demo, and then adjust the power to the maximum.

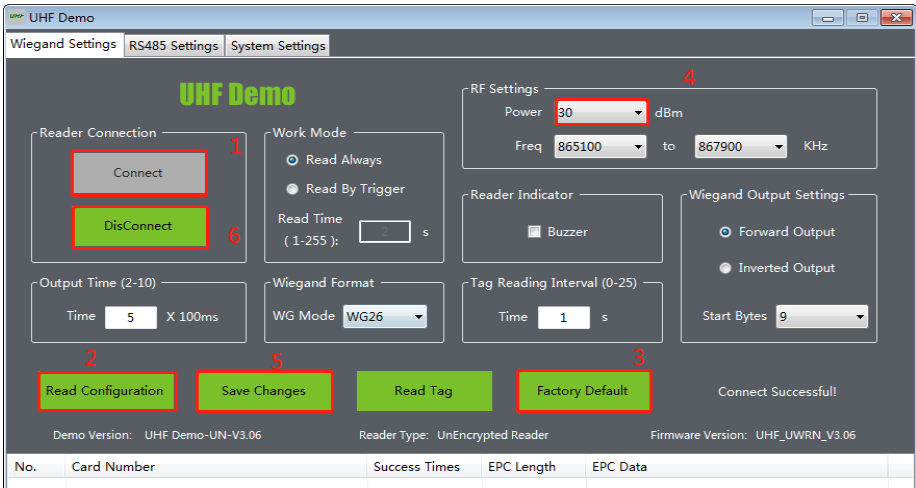

- Check whether there is any interference of the adjacent reader and power station magnetic field near the reader.
- Check whether the reader is installed correctly and whether the tag is operated correctly.
- Replace the tag or reader.

➤ **What can be done if the reader doesn't read the card?**

Try the following possibilities:

- When the reader is connected to DEMO, you need to click **Disconnect** so that it could read the card again.
- Connect the Demo to check whether the manual card reading is normal. If the manual card reading does not respond, there is a problem with the reader. If the manual card reading fails after the factory reset, replace the reader.
- Determine whether the tag is our product, replace the tag test.



➤ **What to do if the barrier doesn't open after reading the card?**

Try the following possibilities:

- Short circuit the NO and COM terminals of the reader, check whether the switch is open. If it is not open, check whether the connection between the reader controller port and the barrier port is correct.
- Check whether the barrier is open when the UP and GND terminals are short circuited. If not, the barrier is faulty.
- Check whether the tag has registered the information on the software and the data is synchronized to the reader. When swiping the card, pay attention to whether the controller has the sound of relay jumping, and whether the software has the normal door opening record display. If so, check whether the output port of the controller relay signal is connected to the brake in a wrong manner or connected to another output port.

ZKTeco Industrial Park, No. 26, 188 Industrial Road,  
Tangxia Town, Dongguan, China.

Phone: +86 769 - 82109991

Fax : +86 755 - 89602394

[www.zkteco.com](http://www.zkteco.com)

