



TS200 Series

TS200 Tripod Turnstile

TS201 Tripod Turnstile

(w/ controller and RFID reader)

TS202 Tripod Turnstile

(w/ controller and combination fingerprint & RFID reader)

The ZKTeco TS200 tripod turnstile series is a compact and cost-effective entrance control system designed for high-traffic volume.

TS200 is a single-lane tripod turnstile series designed for smooth and silent operation and draws very little power. It's made of stainless steel which makes TS200 highly durable.

TS200 tripod arms are normally held in a locked position, thus denying access to the secured side. Upon TS200 reader (RFID and/ or fingerprint) positively recognizing a user's valid access card or fingerprint, its tripod arms unlock, thus allowing users passage to the secured side.

During emergencies and power outages the tripod arms completely collapse, thereby ensuring users FAST unencumbered exit to safety.

TS200 provides both security and convenience, all in a very durable compact design.

Features



Reliability

- Alloy steel tripod hub and SUS304 stainless steel casework & tripod arms ensure long-lasting durability
- Power conservation. Electro-magnetic locks remain in "standby mode" until turnstile is activated
- Patented oil lubrication system reduces need for maintenance
- High quality electrical components



Safety Features

- Tripod-arms unlock & drop during emergencies /power loss
- Visual indicator for access granted (or denied)
- Ergonomic design makes card and fingerprint authentication fast & simple for users
- Secure. Supports Anti-tailgating

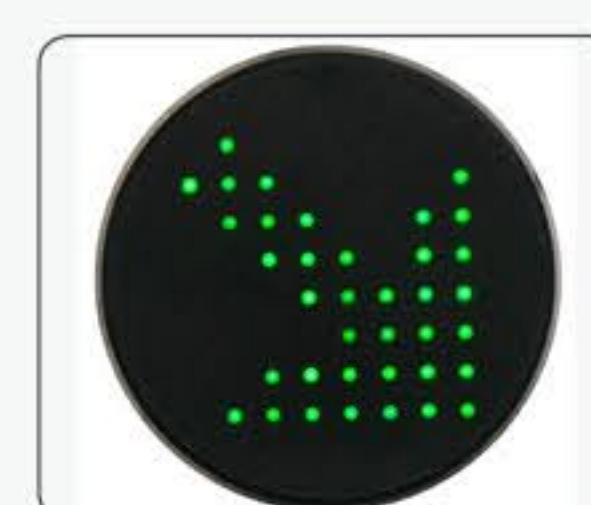

Built-in Reader Integration

- TS200 series ships already integrated with our customers' preference for either card or fingerprint access control reader. This greatly reduces installation time & expense
- TS200 series and associated access control readers are all factory-tested prior to shipping



Specifications

Power requirements		AC 110V/220V, 50/60Hz
Power consumption	Starting	73W
	Standby	20W
	Unlock	63W
Working temperature		-28 °C - 60 °C
Working humidity		5%-80%
Working environment		Indoor/Outdoor(if sheltered)
Speed of throughput	RFID	Maximum 30/minute
	Fingerprint	Maximum 25/minute
Lane width(mm)		505
Footprint(mm*mm)		785*1200
Dimension(mm)		L=1200, W=280, H=980
Dimension with packing(mm)		L=1275, W=370, H=1067
Net weight(kg)		46
Weight with packing(kg)		54
LED indicator		Y
Cabinet material		SUS304 Stainless Steel
Lid material		SUS304 Stainless Steel
Barrier material		SUS304 Stainless Steel
Barrier movement		Rotating
Emergency mode		Y
Security level		Medium
MCBF		3 million
Options/Accessories		Counter, SUS316 Cabinet and Lid, Remote Control

Dimensions (mm)

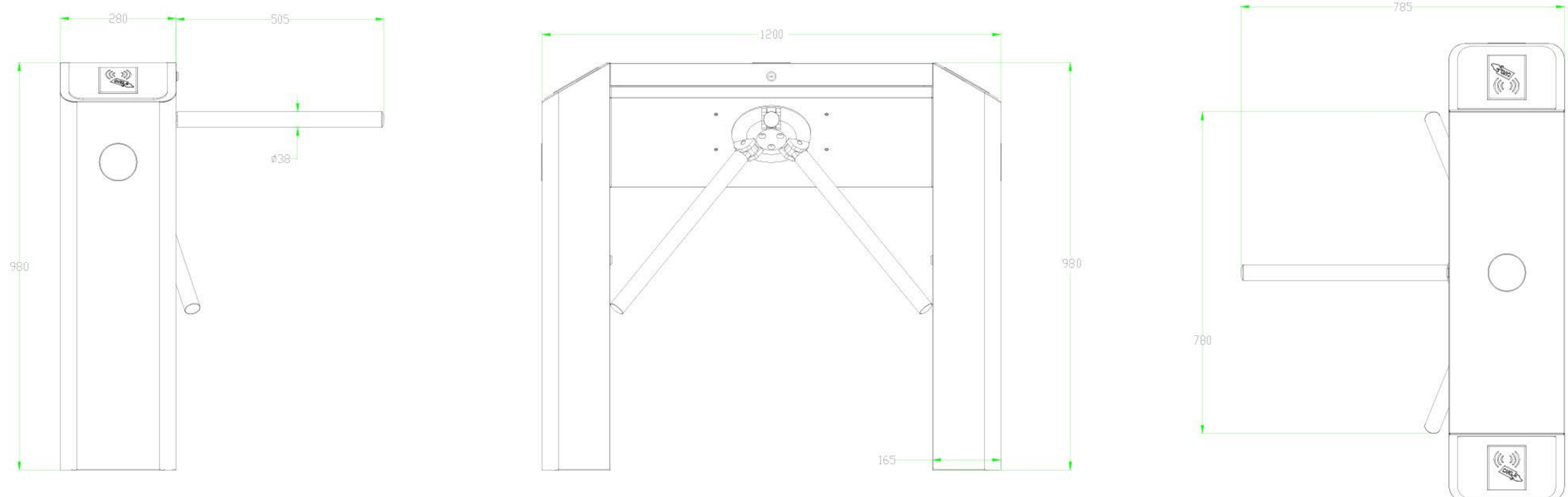

ZKTECO CO.,LTD.
www.zkteco.com
 E-mail: sales@zkteco.com

© Copyright 2018. ZKTECO CO., LTD. ZKTeco Logo is a registered trademark of ZKTECO CO., LTD. or a related company. All other products and company names mentioned are used for identification purposes only and may be the trademarks of their respective owners. All specifications are subject to change without notice. All rights reserved.

