

USER MANUAL

Promerc Series - Color Screen Consumption Machine

Date: Jun, 2017

Version: 3.2

Contents

1 General Summary	1
1.1 Preface	1
1.2 Characteristics	1
1.3 System functions	1
1.4 Flow-process diagram of consumption.....	3
1.5 Appearance and connection of consumption machine.....	4
1.5.1 Front of consumption Manager	4
1.5.2 Consumption machine front of the consumer	6
1.5.3 Bottom of the consumption machine.....	7
1.5.4 Install of the consumption machine (hanging type 10)	8
1.5.5 Connection of the consumption machine.....	9
2 Functional detailed explanation of consumption machine, cashier and subsidy machine	11
2.1 Function introductions of consumption machine.....	11
2.1.1 Main menu of the consumption machine	11
2.1.2 Communication setting.....	13
2.1.2.1 Network setting.....	13
2.1.2.2 Serial interface settings.....	13
2.1.2.3 Connection setting.....	14
2.1.2.4 WI-FI setting★	14
2.1.2.5WI-FI network★	15
2.1.3 Consumption mode.....	15
2.1.4 Consumption management.....	16
2.1.4.1 Data checking	17
2.1.4.2 Setting of the consumption interval.....	19
2.1.4.3 Use the account.....	20
2.1.4.4 Finger printer verification is supported★.....	21
2.1.5 U disk management.....	21
2.1.6 System settings	21
2.1.6.1 Time and date setting.....	22
2.1.6.2 Parameter setting.....	22
2.1.6.3 Machine password settings.....	23
2.1.6.4 Manager settings	23
2.1.6.5 System testing (Only horizontal type 60)	24
2.1.6.6 Restore factory settings	25
2.1.7 System information.....	26
2.2 Introduction of cashier function.....	26
2.2.1 Main menu of the cashier.....	26
2.2.2 Cashier management	28
2.2.2.1 Recharge query.....	28
2.2.2.2 Recharge statistics.....	29
2.3 Function of subsidy machine.....	30
2.3.1 Main menu of subsidy machine.....	30

2.3.2 Subsidy management	31
2.3.2.1 Subsidy details enquiry.....	31
2.3.2.2 Subsidy statistics.....	32
2.4 Consumer operation panel.....	33
3 Operation process of consumption machine	35
3.1 Promotion of credit card.....	35
3.2 Design of main process.....	38
3.3 Design of consumption machine process.....	39
3.4 Process of frequency calculation.....	41
3.5 Timing process.....	42
3.6 Process of recharging machine.....	43
3.7 Process of subsidy machine	44
Appendix T9 Typewriting★.....	45

1 General Summary

1.1 Preface

The consumption system includes a consumer machine and a set of consumer software, in which the machine set consumer machine, cashier, subsidy machine three major functions in one. The system is divided into machine operation and software operation. Switch between consumer machine, cashier, and subsidy machine by machine operation. In addition to all the functions on the machine, the software also integrates a large number of other functions, such as data settings, financial statements, and so on. The interface of the system is simple and clear. It is easy to operate, and has fully function, which has stable and reliable system, greatly improving the management efficiency.

This file is mainly for the introduction of machine operation part. About software operation, please refer to <user manual of consumption machine>.

1.2 Characteristics

- Firmware adopts 32 bit kernel processor, and its performance is superior.
- The software architecture adopts C/S structure.
- Back ground database adopts SQL Server 2000 and SQL Server 2005.
- Double color screen display and double keyboard operation

1.3 System functions

● Consumption machine

Consumption mode: Support fixed value, amount, key value, count, time, and merchandise.

Self-service operation: You can report the lost, delete the lost report and modify passwords directly on the consumption machine. ◦

Working mode: Support offline and real-time consumption.

Settings of cards: limit the time, amount, valid use period, available meal, consumption discount and machine authority and so on.

Correction function: Support machine correction to correct everyone's last consumption record, and support correction on software at the same time.

Voice play: When the card is consumed, it announces whether the consumption is successful or not, and other prompt voice.

Manager/operator management: Support administrators to manage machines. At the same time, it supports operators to lock and unlock the machine, so as to facilitate statistics of the sales situation of each operator.

Batch consumption: people with different batches have meals at different eating period.

Subsection fixed value: support multiple time interval value settings.

Supplement orders: Support those who do not have the card to eat first, then make up the order. ◦

Support multiple restaurant and department authority: Assign the authority, this operator can only operate the machine or data of this restaurant or its department.

Support bookkeeping consumption, do not deduct the amount on the card, only deduct the amount of the account.

- **Cashier**

Discount recharge: Set the discount rate and recharge according to the preferential ratio.

Cashier mode: Two modes, fixed value and manual input amount mode are supported.

Cashier type: : Support recharge and refund; refund is no discount ratio.

- **Subsidy machine**

Accumulation subsidy: When it is accumulation subsidy, the amount of different subsidy can be accumulative subsidy, otherwise only the last subsidy can be subsidized.

Clear subsidy: When the subsidy is made, the amount of the card will be cleared to prevent the amount of subsidy from being used in the next one.

subsidy by pressing the confirm key: When the "confirm" key subsidy mode is selected, the user is required to press the "confirm" key to make the subsidy, otherwise there will be no subsidy.

1.4 Flow-process diagram of consumption

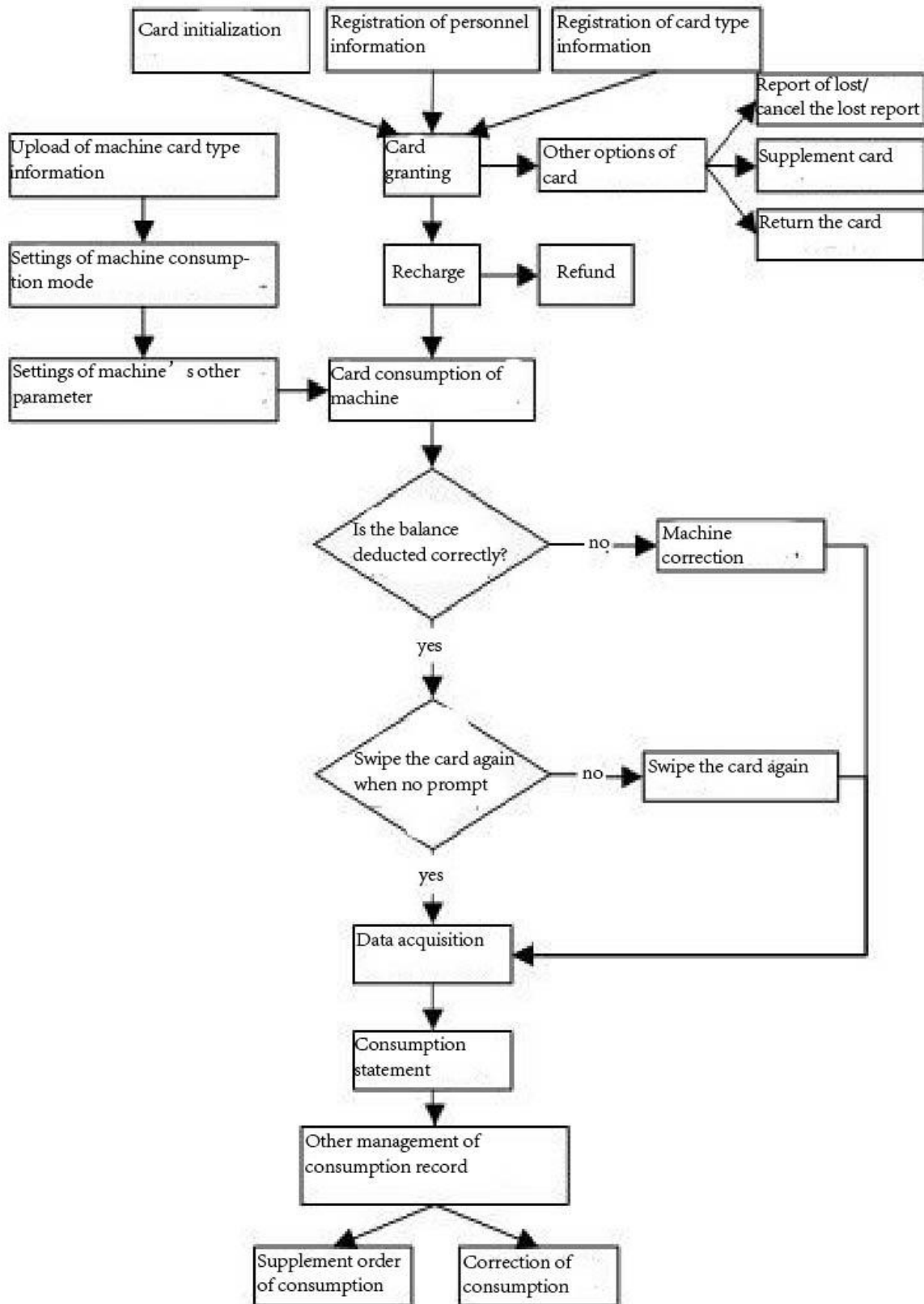

1.5 Appearance and connection of consumption machine

1.5.1 Front of consumption Manager

- **Hanging type 10**

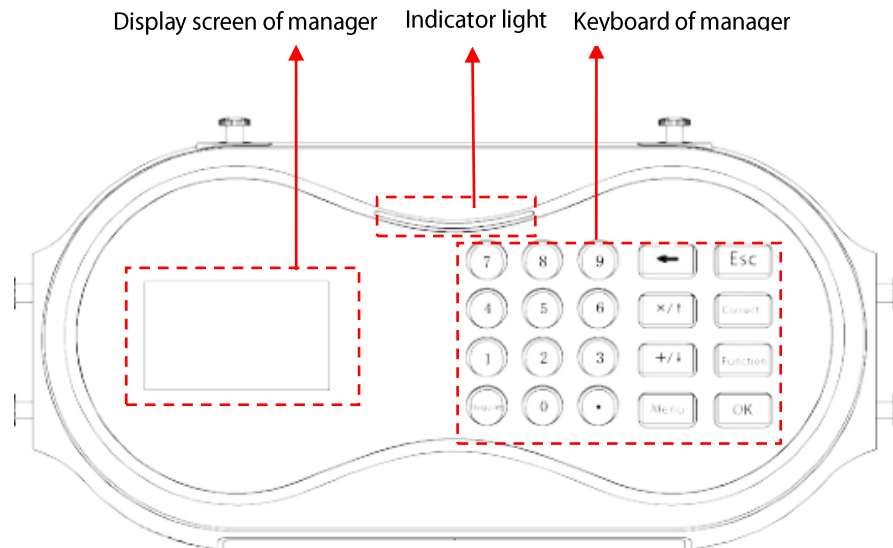

- **Horizontal type 20**

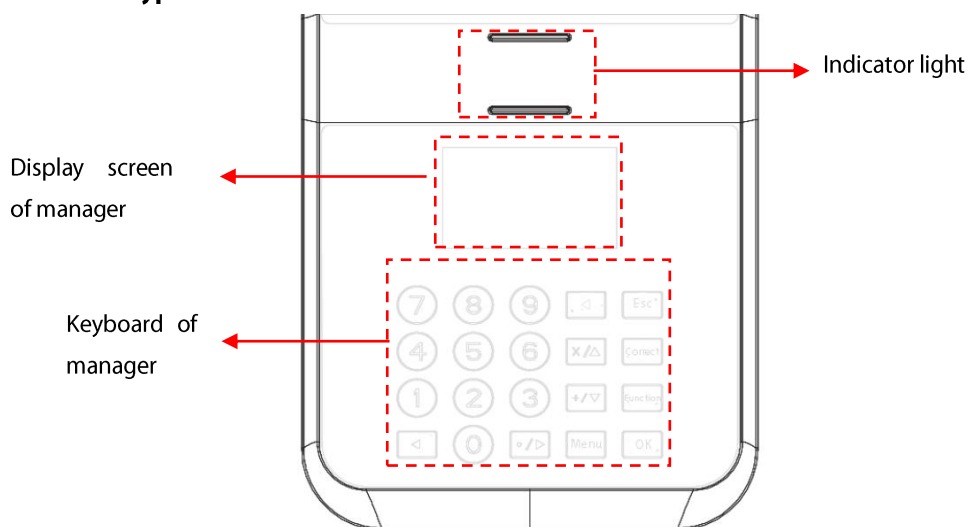

1、Display screen of manager

- When there is no consumption then display amount, balance, date, time, mode of consumption, and whether online or not.(The symbol is S).
- when consumption happens, the interface real-time indicate the card information of transaction, such as deduction amount, balance, card number, and whether the consumption is successful or not.

2、Indicator light

Working normally: the green light flicker once per second.

Verification failed: the red light is on.

Verification success: the green light is on.

If an abnormal occurs, such as several cards in the credit card area at the same time, the machine can not read

the card so the indicator will not respond. If the card is normally credited, the card has been kept in the credit card area, and the green light has always been on, and returns normal after the card leaving.

3 · Keyboard of manager

Numeric key (1-9): input numbers (for example amount).

【0/⊙】 power button (only hanging type 50) and numeric key 0.

【Query/◀】 : Enters the consumption statistics query window through the standby interface. When operate the menu, slides one by one to the left, and when operate the options, switches forward.

【×/▲】 : When operate the menu, slide it one by one up forward. When operate the options, switches forward. When input the amount under the amount mode, push the [×] button to do the corresponding multiplication operation.

【+ / ▼】 : When operate the menu, slide it downward one by one. When operate the options, switches backward. When input the amount under the amount mode, push **【+】** button to do the corresponding add operation.

【./ ▶】: When operate the menu, slide it right forward one by one. The decimal point when input the amount. When operate the options, switches forward.

【Backspace】 : Only under the amount mode input the amount, push this button to delete the input number, and then re input is allowed.

【Cancel】 : When operate the menu, return to the previous menu. Under the edit mode or quit the menu, quit the edit mode or quit the menu will not save the result.

【Correction】 : Allow correct the last consumption record in the equipment.

【Function】 : Backup.

【Menu】 : Display the main menu under the normal mode.

【Confirm】 : When operate the menu, enter the sub-menu of the corresponding menu. When operate the options, enter the editable mode, press [confirm] button to save the settings. Press the [confirm] button to enter the card mode under the amount mode, key value mode and commodity mode.

1.5.2 Consumption machine front of the consumer

- **Hanging type 10**

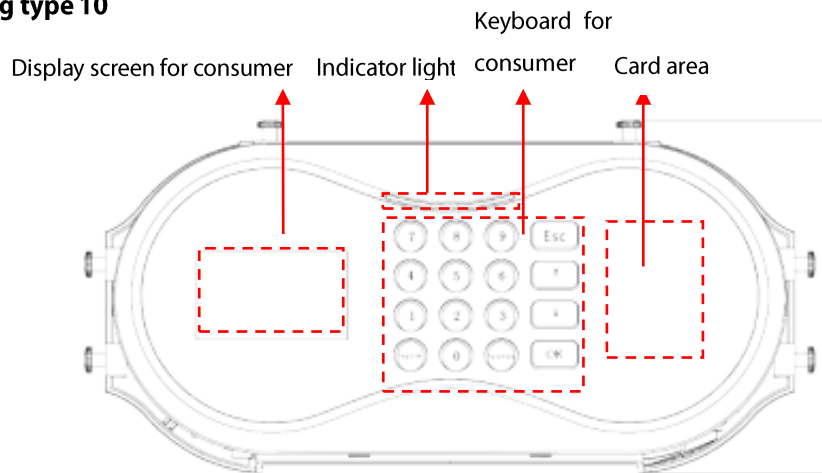

- **Horizontal type 20**

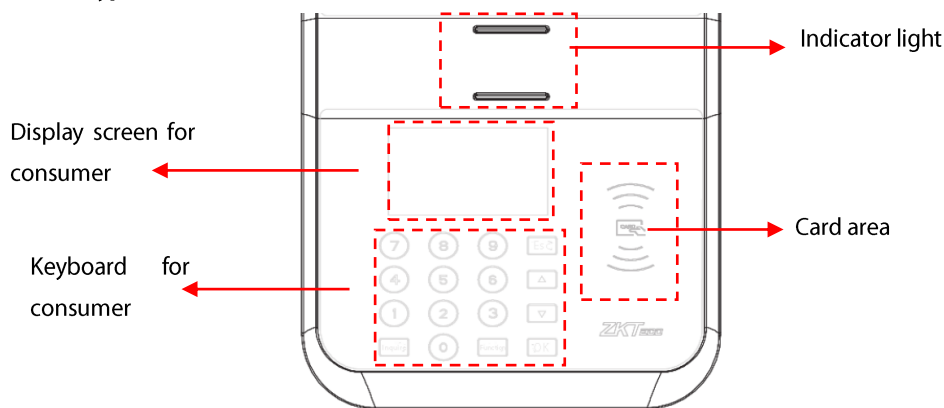

1 - Display screen for consumer

Except for report lost, cancel the lost report and change the password operation, other operation have the same display method with the manager display.

2 - **Indicator light:** The same as the indicator light of manager interface.

3 - Keyboard for consumer

Numeric key (0-9): Input number.

【Confirm】 : Confirm information.

【Cancel】 : Cancel information.

【Function】 : Enter the operate menu interface of consumer, please refer to 2.4 operate menu of consumer. [2.4 Consumer operation panel](#) .

【Query】 : Enter the detail query interface.

【↑】 / 【▲】 : Operation menu, upward or left forward slide one by one, when operate the options, switches forward.

【↓】 / 【▼】 : Operation menu, downward or right forward slide one by one, when operate the options, switches backward.

4 - Card area

The sensor area for card holders' credit cards.

1.5.3 Bottom of the consumption machine

- **Hanging type 10**

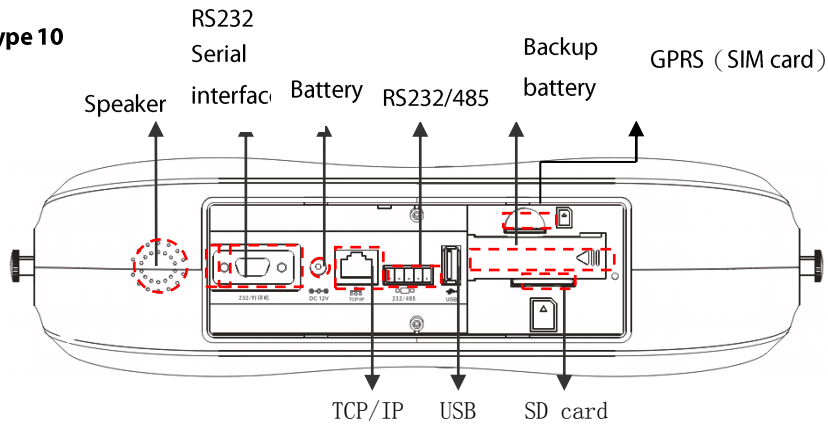

Speaker: Output voice.

RS232 Serial interface : To be connected with printer and bar code scanner, etc.

Battery: Input DC 12V battery.

RS232/485: To be connected with computer.

Backup battery: Backup battery can be installed here after open the cover.

GPRS(SIM card): Connect to WI-FI★.

TCP/IP: Connect to computer or network.

USB: Upload or download data, and connect to U disk or fingerprint scanners.

- **Horizontal type 20**

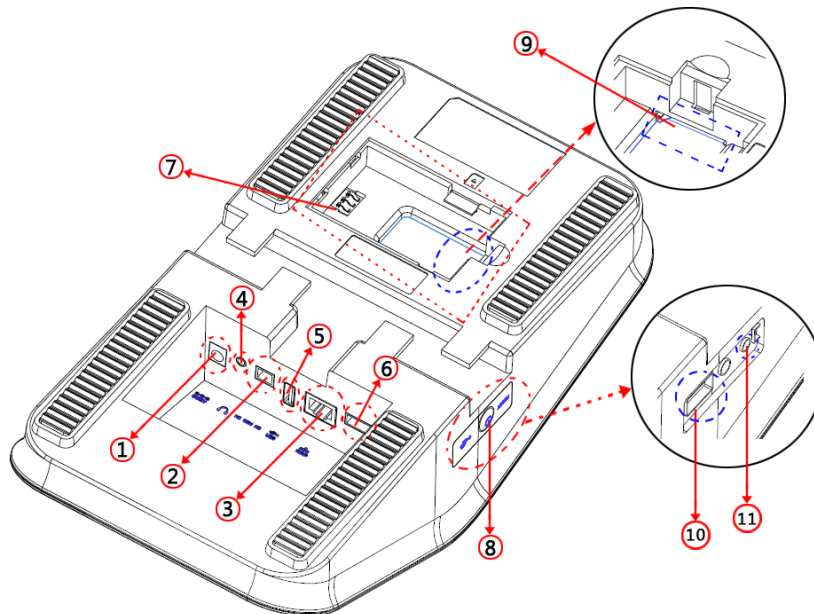

1. Battery	6. RS232/485 interface (connect to printer)
2. Relay interface	7. Backup battery
3. TCP/IP interface	8. Power button.
4. Speaker interface	9. SD card socket
5. USB socket	10. USB socket
11. Reset button	

1.5.4 Install of the consumption machine (hanging type 10)

This kind of consumption machine has 2 install methods. The user can choose the proper method according to the location of install support. 2 install methods show as below.

- **The first method, side fix install.**

1、Fix the hanging board and the consumption machine with screws:

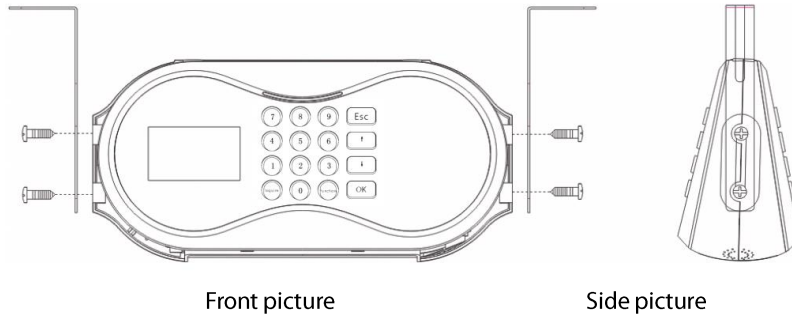

2、And then fix the hanging board to the support with screws.

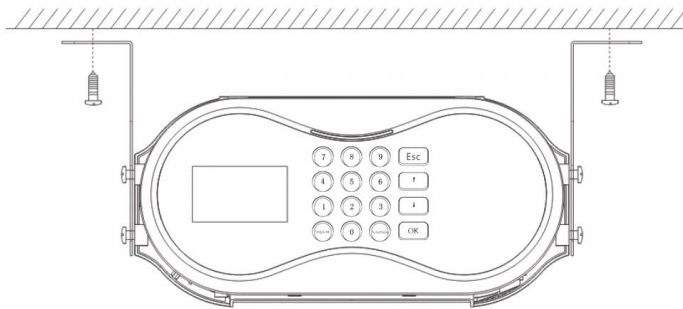

- **The second method, up fix install**

1、Fix the hanging board and the consumption machine with screws:

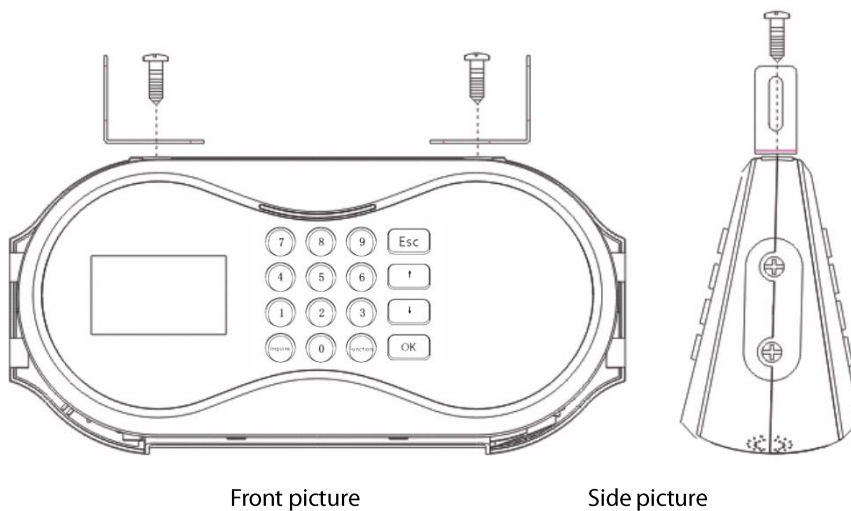

2、And then fix the hanging board to the support with screws.

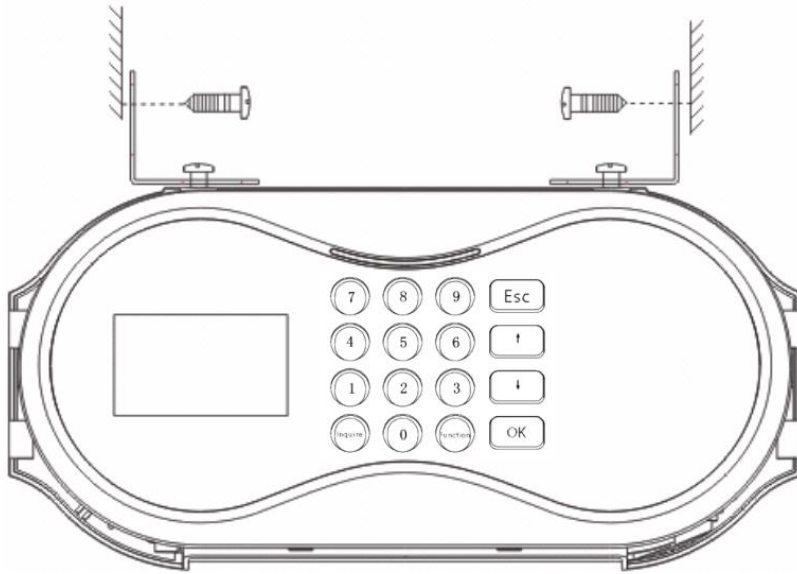

1.5.5 Connection of the consumption machine

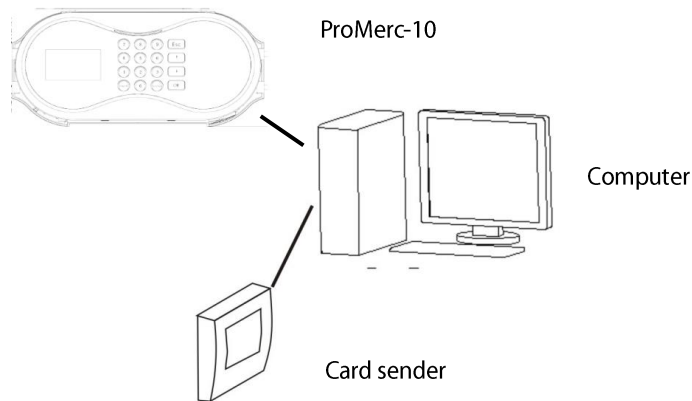

- 1 · Card sender connect with computer through USB interface.
- 2 · There are 4 connection methods between consumption machine and computer:

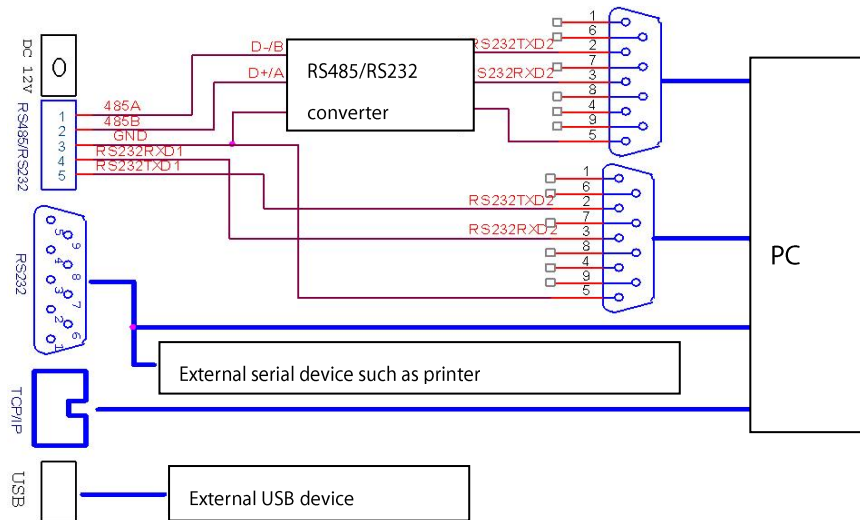

3 - The explanation of DB9 shows below:

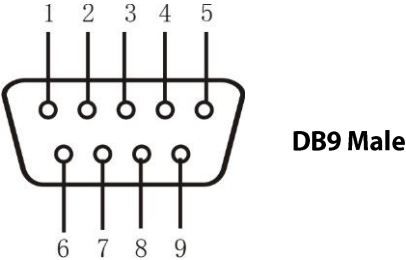

Definition of every stitches:

- 2---RXD
- 3---TXD
- 5---GND
- 1,4,6,7,8,9--Empty

2 Functional detailed explanation of consumption machine, cashier and subsidy machine

The type of the machine is consumption machine. There's no special explanation in this menu, all button operation is operated on the manager keyboard.

When you turn on the battery, it will be a session display on the screen, and after the machine totally started, display the initial interface (standby interface). Every time return to the regular mode from menu, the display content will be different according to the different settings of the menu.

Initial interface:



Enter the menu by press the 【menu】 button on the keyboard of the manager under the normal mode.

©**Note:** If the manager card is sent and upload to the equipment in the consumption software, then press [menu] enter the main menu, system will alert "please use manager card".

Only after using the manager card, will enter the main menu. If there's no manager card uploaded, then no card needed before enter the main menu. Send and upload of manager card please refer to <user manual of the consumption soft>[2.6.1.1 Register administrator card](#) ◦



● Operation instructions

Choose the subject you want to operate by press the ▲/▼/◀/▶ button on the keyboard, and press [confirm] enter the corresponding menu. If the user has no operation for a while, then return to the normal menu.

2.1 Function introductions of consumption machine

2.1.1 Main menu of the consumption machine

Press [menu] button enter the main menu after turn on the machine (machine type is consumption machine). Main menu contains 6 subject shows as below:



Communication settings: network, interface, connection, WI-FI ★ and WI-FI network settings.

U disk management: you can download and upload the user list, download and upload fingerprint data, upload card type record, upload commodity record, download consumption record, update hardware and parameter through U disk.

System setting: settings of machine time, factory reset, whitelist check, operator card check, machine type(consumption machine/casher/subsidy machine), password, voice alert, volume.

Consumption mode: set the fix value parameter, such as fix amount, start subsection fix value, set the timing parameter, like time price, unit price. Set the consumption mode, fix value, amount, key value, count time, commodity, timer mode.

Consumption manage: data checking (checking of the consumption detail, consumption statistics checking, meal type statistics checking), set the consumption period(fix time setting, batch time interval setting),use accounting and finger print verification.

System information: check the register user amount, manage the record amount, consumption record amount and device information.

- **Operation explanation**

Press ▲/▼ to choose the subject of the menu, press [confirm] enter the sub-menu. In the sub-menu, press [cancel] and return to the main menu. In the main menu, press [cancel] and return to the normal mode.

☞**Special note:** 当 When set the machine type as cashier or subsidy machine, you need to return to normal mode first, and then press [menu] button enter the main menu, the consumption mode will be cashier manage or subsidy manage.

2.1.2 Communication setting

Set the parameter of communication between device and PC, including IP address, gateway, subnet mask, baud rate, device number, communication password, etc.

In main menu, press ▲/▼/◀/▶ to enter the setting of communication, press [confirm] enter the sub-menu of the communication setting.

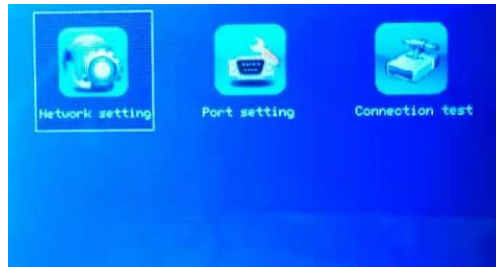

2.1.2.1 Network setting

When use Ethernet as the communication method of device and PC, following settings need to be checked:



IP address: default IP is 192.168.1.201, you can change it as you need. IP can 't be the same as the connection PC.

Subnet mask: default subnet mask is 255.255.255.0, you can change it as you need.

Gateway: default address is 0.0.0.0, if the device is in the different network segment with PC, then the gateway address also need to be set.

Server IP: 当 when using lost report, cancel lost report, change the password and other functions, consumption software in the computer need to be turn on, at the same time, set the server IP as the computer IP of the running consumption software.

User can set the communication IP address of device here. Press ▲/▼ to switch between four groups of data, press number key to input new data. After setting these, press [confirm] to save the modify actions and then return to the original menu, or press [cancel], not to save the modify actions and then return to communication sub-menu.

2.1.2.2 Serial interface settings

When the device and the PC use the serial interface (RS232/RS485) as the communication method, following settings need to be checked:

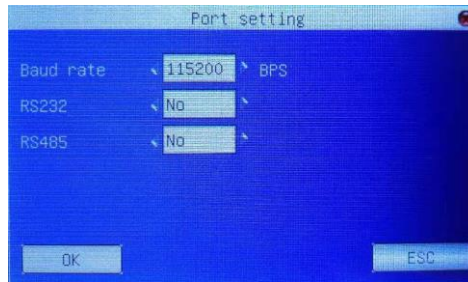

Baud rate: the communication rate with PC, has 9600, 9200, 38400, 57600, 115200 these five options. High speed communication is fast, so RS232 communication is recommended. Low speed communication is stable, so RS485 is recommended.

RS232: Use the RS232 to communication or not. If use RS232 communication line, choose “yes”.

RS485: Use the RS485 to communication or not. If use RS485 communication line, choose “yes”.

2.1.2.3 Connection setting

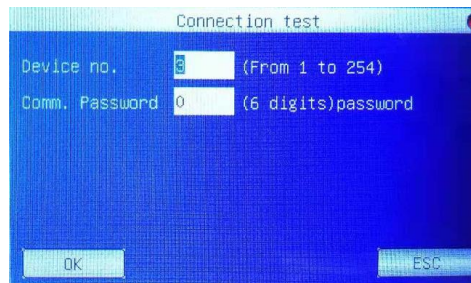

Device number: the number of the device, 1~254, if use the RS232/RS485 communication method, then this device number needed to be input in the software login interface.

Communication password: In order to increase the security and confidentiality of data, the connection password can be set here. When the software needs to connect with device and read the data, the connection password has to be input. The default password is 0(that means no password), other value can be set, too. If the software needs to communicate with the device, then connection password must to be input, or it will be failed. The length of the password is 1-6.

2.1.2.4 WI-FI setting★

Before the device using WI-FI, for other Physical components of 802.11 network, such as access point, distribution system and wireless media must be there. And the ESSID of the connected network must be known (Network identification name).

Network identification ID: the network identification name of the WI-FI network connection (difference letter size).

Network mode: there are 2 mode, Infrastructure Model and Ad—hoc Model, infrastructure mode is corresponding to star shape structure network, Ad-mode is corresponding to point to point network.

Identification type: Basic structure mode contain 5 kinds of identification type, including: OPEN, SHARED, WPAUTO, WPAPSK and WPA2PS002E ◦

Ad-hoc model contains four verification types, including OPEN, SHARED, WPAUTO and WPANONE.

Encryption method: When encryption method is NONE, then the password of WEP (Wired equivalent privacy) and WPA (Wi-Fi protected access) isn't editable, that means no need to input password.

IP address of local device: If there's dynamic distribution address function (DHCP) in 802.11 network, or input the right IP address in the specified IP interface, subnet mask, etc.

- **Operation instruction**

Press ▲/▼ move cursor to input box or button, start T9 type writing ★ (please refer to the addition instruction) input network identification ID, it must to be input, or the cursor can't move into other input box. Choose the setting subject of other input box by ◀/▶, or locate it in the button and press [confirm] enter the corresponding operation.

1、 Set the password

According to the different verification method and encryption method, the setting password and the interface of password setting can be different, too. There are 2 setting interfaces, WEP and WPA.

- **WEP password**

Input the rightful password, there are four groups of password, if all these passwords are set and set rightful, only the chosen password is the valid value.

- **WPA password**

Input the rightful password, press [confirm] or [menu] to save the settings, and then return to the WI-FI setting interface.

2、 Appointed IP

Appoint the IP in the WI-FI network of the device. It can't be in the same network segment with communication settings, or it may causes WI-FI disconnected.

After appoint IP, press [confirm] or [menu] return to last interface, press [cancel] cancel settings and return to last interface.

2.1.2.5WI-FI network★

Check the WI-FI signal of current environment for the device and choose a better network to provide evidence.

Press [confirm] and set the chosen network.

Press ◀ and refresh the list.



Note: setting of communication password in the software, please refer to <user manual of consumption soft>[2.7.4 Equipment registration](#) .

2.1.3 Consumption mode

In the main menu, press ▲/▼/◀/▶ enter the consumption mode, and then press [confirm] enter the sub-menu of consumption mode.

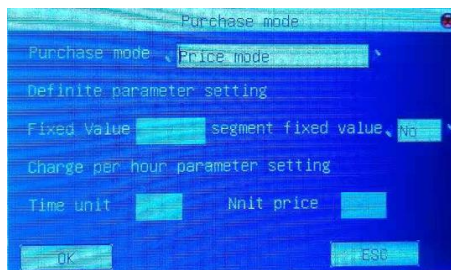

Consumption mode: including fix value mode, amount mode, key value mode, count mode, commodity mode, and timer mode.

- **Fix value mode:** consumption as the fix value.
- **Amount mode:** input amount on keyboard to consume.
- **Key value mode:** consumption is based on the amount of the button, and the key amount is uploaded from the software to the machine, more detail please refers to <user manual of consumption software>.
- **Count mode:** only count the number of times and without charging.
- **Commodity mode:** commodity information can be obtained through commodity coding. The information is uploaded from the software to the machine. More detail please refers to <user manual of consumption software>.
- **Timer mode:** consumption according to time, the first time credit card shows "Welcome" and the second time shows consumption information, the amount of consumption according to the timing parameter settings.

Setting of fix parameter: when the consumption mode is selected as the fixed value mode, the fixed amount parameter value can be set. When segmented values are enabled, consumption is fixed within a specified period of time.

Setting of timing parameter: The timing parameter can only be set when consumption mode is selected as time consumption. **Unit time refers to the minimum consumption time (unit is minute). Unit price is the charge per hour (unit is yuan). For example, if the unit time is set to "10" minutes and the unit price is "60 yuan per hour", the charge will be 10 yuan per 10 minutes.** If the consumption time is 27 minutes, the amount of consumption should be charged is $30/60*60=30$ yuan, that is, "consumption amount = consumption time (take whole)/60* unit price". (Note: In this case, the consumption time is 27 minutes, the unit time is "10" minutes, and the consumption time is 30 minutes.)

- **Operation instruction**

Move ► to the subject needed to be set, press numeric key to input data, choose subject by pressing ▲/▼. Press [confirm] save the settings, or press [cancel] cancel these settings.

2.1.4 Consumption management

In main menu, press ▲/▼/◀/▶ enter consumption management interface, press [confirm] enter the sub-menu of consumption management.

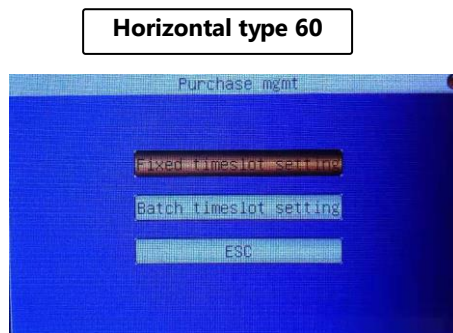

2.1.4.1 Data checking

2.1.4.1.1 Detail check of the consumption

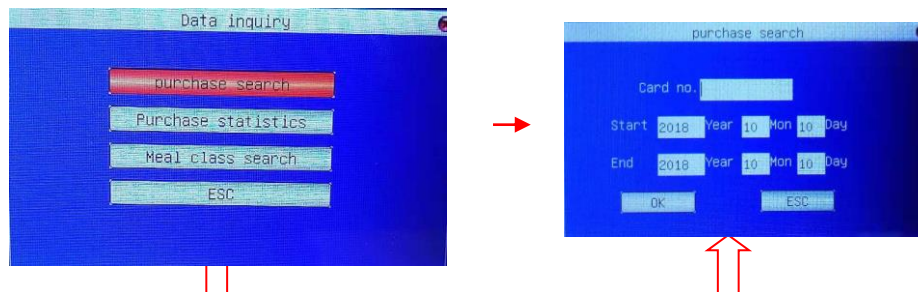

On the initial interface, press the [query] key, enter the data query window, press the [confirm] key directly, enter the consumption details query window.

Card number: Enter the checking card number.

Start and end dates: Enter the start date and end date of the checking record.

- **Operation instructions**

Press ▲/▼ key move cursor to the item to be set. Enter the value to be set by pressing the keypad numeric key. After entering the value, press [confirm] key to query the qualified record. If there is a record, the screen will display a qualified record. If the record is long, press ▲/▼ check it one by one. Press ◀/▶ check it page by page. If there is no record, the screen will display "no record". After enquiry the value, press [cancel] key to return to last menu.

2.1.4.1.2 Consumer statistics query



In the data query window, press▲/▼to the consumption statistics option, press the [confirm] key, enter the consumption statistics query window.

- **Operation instructions**

The consumption statistics query is the statistical information about the consumption records of the input card numbers within the time limit of input. Operation with the preceding consumer detailed query, no longer reiterated here.

2.1.4.1.3 Meal type statistics query

In the data inquiry window, press ▲/▼key to the menu statistics inquiry options, press the [confirm] key, enter the menu statistics inquiry window.

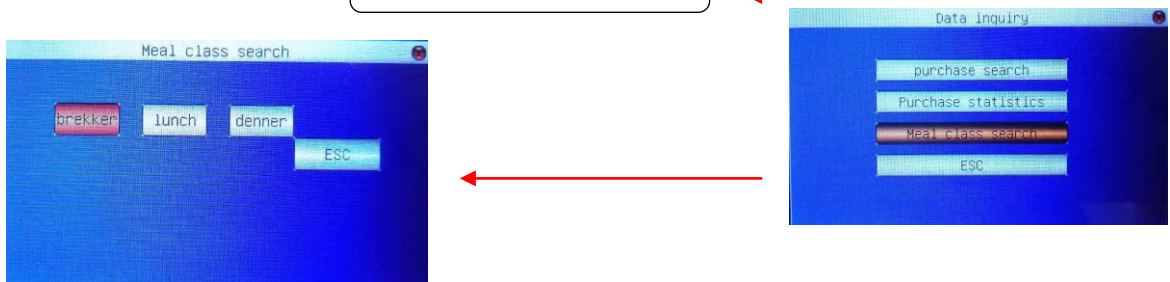

The device does not have any meal to be inquired by default, it needs to be set up by management software. More detail please refer to < user manual of the consumption software > [2.7.5 Machine settings](#). After set the meal type, you can check it, such as breakfast, lunch, supper and night snack in the picture above. Users can set up according to need.

For example, choose breakfast and press the [confirm] button to enter the following window.

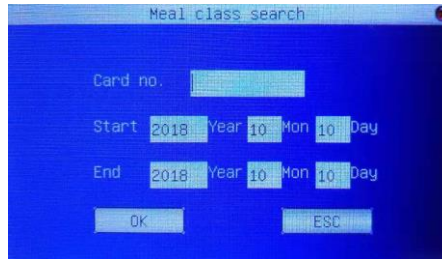

Meal type statistics query is the statistics of all card numbers, so the default is all card numbers, do not need to enter card numbers. Enter the start and end times of the query, press the confirm button, and the eligible meals will be displayed on the screen.

2.1.4.2 Setting of the consumption interval

Consumption type is consumed according to the specified time period. The time period is divided into fixed time periods and batches of time periods.

2.1.4.2.1 Fixed time settings

In the Consumption Management menu, press ▲/▼/◀/▶ key to set the options for a fixed period of time, press the [Confirm] key to enter a fixed period of time setting window.



There are eight periods of time, setting the start and end time periods.

- **Operation instructions**

Press_/to move up and down, press ▲/▼ key to move between columns, or forward ◀/▶ backward to move the cursor one by one. Move cursor to set the input box, press the small keyboard numeric key to enter the value to be set. Time range: 00:00-23:59. The starting time for each time period should be less than the end time. After setting the time value, then press the [Confirm] button to return to the last menu.

2.1.4.2 Setting of batch time interval

Press ▲/▼/◀/▶ to set the batch time interval option, press the [Confirm] key to enter the batch time interval setting window.



Dining batches can be divided into eight batches, where users can enter the batch they want to set, press the [Confirm] key to enter the batch corresponding to the fixed segment settings.



There are eight time periods in total, setting the start and end time periods.

This operation is the same as fix time settings, no more details.

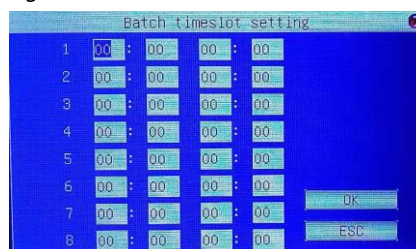

2.1.4.3 Use the account

When "Yes" is selected for the use of accounting, the cardholder does not deduct the amount on the card, but deducts the amount on the account. Deduct the amount of the card when you choose "no".

2.1.4.4 Finger printer verification is supported★

When choosing "yes", fingerprint verification is needed when the cardholder consumes excessive consumption. No fingerprint verification is required when choosing "no", so only the password is input when the overhead consumption occurs, and the device needs to be restarted to take effect.



Note: To support fingerprint verification, we need to select and support external fingerprint devices. ◦

2.1.5 U disk management

In the main menu, press the button ▲/▼/◀/▶ key to the U disk management option, press the [confirm] button to enter the U disk management sub menu.



Download user list: Save the list of users in the device to the U disk. ◦

Upload user list: Upload the user list of U disk to the device.

Download fingerprint data: Save the fingerprint template in the device to the U disk.

Upload fingerprint data: Upload fingerprint template from U disk to device.

Upload card record: Uploading the card records on the U disk to the device.

Upload product record: Upload the merchandise record on the U disk to the device.

Download consumption records: Save the consumption records in the device to the U disk.

U disk upgrade firmware: The firmware of the device can upgrade using this option to upgrade files in the U disk.

U disk upgrade parameters: The firmware parameter settings of the device can be upgraded using the upgrade file in the U disk.



Note: If you need such an upgrade file, you need to contact technical support personnel. In general, it is not recommended to upgrade firmware and parameters.

● Operation instructions

Insert the U disk with upgrade file into the U disk slot of the device. Click this button and the device will automatically identify the upgrade file for upgrade. If the upgrade succeeds or fails, the device will be prompted accordingly.

2.1.6 System settings

In the main menu, press ▲/▼/◀/▶ key to the system settings options, press the [Confirm] key to enter the system settings submenu window.



2.1.6.1 Time and date setting

The time and date of the equipment need to be set up accurately to ensure the accuracy of the use time. Enter the time and date setting options, press the ▲/▼ key to switch the input box, and press the keypad number key to enter the value to be set. Press the Confirmation or Menu button to save the settings and return to the previous interface. Press Cancel to cancel the settings and return to the previous interface.

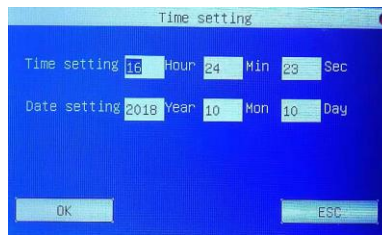

In the system settings window, press the [confirm] button to enter the time setting window:

2.1.6.2 Parameter setting

● Whitelist check

Whitelist through the consumer software settings, included in the white list of cards can be normal consumption, when the card is not a white list and the white list checks to select "yes", the cardholder consumption, will not be able to carry out consumption and alarm. After selecting, press the [confirm] button to save or exit, or press [cancel] to save and exit.



Note: The setup of white list can only be done through consumer software. The acquisition of whitelist can be downloaded from consumer software to the machine. In addition, the system checks the blacklist by

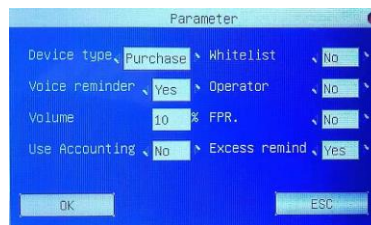

In system settings window, press ◀/▶ key to preferences. Press the [confirm] button to enter the parameter settings window:

● Machine type

The device is default to be the consumer machine. The machine type can be switched between the consumer machine, the teller machine and the subsidy machine. After switching back to the initial interface of the device, enter the menu or restart the device to take effect. The functions of different types of machines are different. See the functional description of consumption management, cashier management and subsidy management in this document. ◦

● Operator (card) checking

When it is set to "yes", the machine must be in normal working condition after the device is started to brush the operator card. And there are operators in every record.



Note: The operator card needs software setup and sent to the device, more detail please refer to <user manual of consumption software>.

● Voice and volume settings

Voice Prompt: Choose whether to give a voice prompt by ◀/▶ key, choose "yes" device will give the corresponding voice prompt in operation, otherwise no prompt.

Volume: Adjust the volume of the device's voice. Range is 1-99%.

● Use accounting

When "Yes" is selected for the use of accounting, the cardholder does not deduct the amount on the card, but deducts the amount on the account. Deduct the amount of the card when you choose "no".

● Exceed validation

When the excess validation chooses "Yes", the user will be prompted to do password validation when the card holder consumes more than the set allowable consumption amount. After password verification is passed, we can successfully consume.

2.1.6.3 Machine password settings

Machine password: Card sector read and write password.



Note: The password should be consistent with the password set in the initialization card, otherwise it will lead to the password error when the machine reads the card.

In the system settings menu window, press ▲/▼/◀/▶ key to the machine password option, press the [Confirm] key to enter the machine password window.



Press the numeric key to enter the 6 bits of the original password; then press the numeric key to enter the 6 bits new password. When you have finished typing the password, press the [Confirm] key to save it. If the old password is typed incorrectly, the screen will prompt you for "password error!" And return to the system settings submenu window.

2.1.6.4 Manager settings

In the system settings window, press ▲/▼/◀/▶ key to select the administrator settings, press the [Confirm] key to enter the administrator settings submenu. It includes two options: administrator permissions and delete administrators.



Note: When administrator settings are set, only local administrator permissions can be set, so the permissions set locally do not necessarily represent the permissions of all machines.

➤ **Manager authority**

Register administrator card here. Before registering an administrator, the registered card needs to be issued by the PC software administrator.

Select the manager authority option to enter, system prompts "please swipe card".



After the administrator card is cleaned, enter the administrator's permission window.

This window displays the card number and the current permissions, where the card number is not set. Privileges can be

selected by administrators and operators.

Manager: After being set up as administrator, you need to brush the administrator card when you enter the machine menu.

Operator: After the operator is set up, the operator card must be checked. The operator can lock and unlock the machine.

Press the [Confirm] button to save the result, or press [cancel] to save the key and return to the next menu.

 **Note:** The registered card needs to be issued by the PC software administrator, and the administrator card has the authority of the operator card.

➤ **Delete manager**

Select Delete administrator option and enter the following interface:



Press the number key to enter the administrator card number to delete, press the [Confirm] key to delete the administrator and return, or press the [Cancel] key to return to last level menu.

2.1.6.5 System testing (Only horizontal type 60)

In the system settings menu window, press ▲/▼/◀/▶ key to the system test options, press the [Confirm] key to enter the system test window.

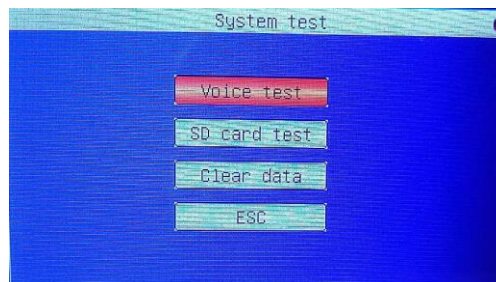

➤ **Voice testing**

1 · In the system test window, press the ▲/▼ key to the voice test options, press the [Confirm] key to enter the voice test window.

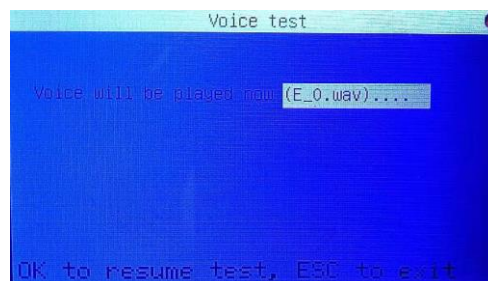

2 · Press the [Confirm] button to continue testing, press cancel to exit the test.

➤ **SD card testing**

1 · In the system test window, press ▲/▼ to the SD card test options, press the [Confirm] key to enter the SD card test window, the window prompts "working now, please wait a moment"

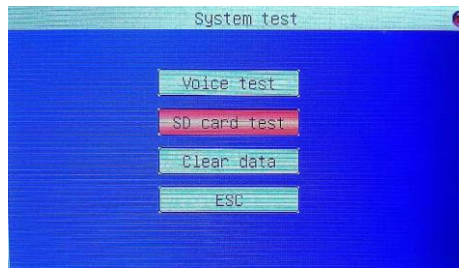

2 - After the SD card test is completed, the "save successfully" prompt box is popped. Press the [confirm] button to close the prompt box

➤ **Clear data**

Clear all the consumption data in the device; once the data is deleted, it is not recoverable.

 **Note:** Before you clear the data, you must insert the U disk with the file named "zkdeldata.sh".

1 - In the system test window, press the ▲/▼ key to clear the data option, press the [Confirm] key to start clearing the data, and the window prompts clearing the data now.

2 - After the data is cleared, the clear success box is displayed:

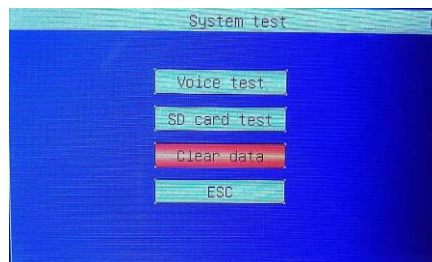

3 - Press the [Confirm] button to close the prompt box.

2.1.6.6 Restore factory settings

Restore the parameter settings in the device to factory settings.

In the system settings sub menu, choose to restore the factory settings option, and whether the device prompt is restored:

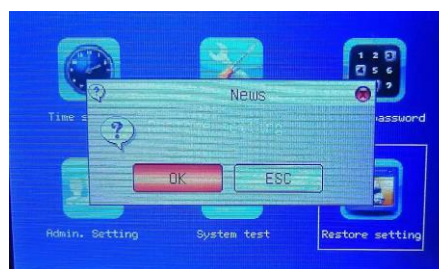

Press the [Confirm] key to confirm and restore the factory settings; when the restore operation is completed, the system settings submenu window is returned automatically. (cancel) key, cancel operation and return to the previous menu interface.

 **Note:** The recovery is only the factory settings of the menu, which will not delete the consumption records in the machine.

2.1.7 System information

In the main menu, press the button ▲/▼/◀/▶key to the system information option, press the confirmation button to enter the system information window.



In this window, users can view the number of main sectors, backup sectors, user records, management records, consumption records, device name, serial number, firmware version number, manufacturer, date of factory.

The main sector and backup sector are the sectors of the device read card.

❖**Note:** Because this device has the functions of consumer machine, teller machine and subsidy machine. Therefore, after switching between different types of machines, the main menu will have some differences, mainly manifested in: consumer machines have consumption mode, consumption management sub-menu, cash register only cashier management, subsidy machine only subsidy management, U-coil management, system information according to different types of machines are slightly different, but the use of the same. Here are the different places in teller machines and subsidising machines.

2.2 Introduction of cashier function

2.2.1 Main menu of the cashier

When the machine type is the teller machine, in normal mode, press the [menu] button to enter the main menu of the teller machine.



Communication settings: Network settings, serial port settings, connection settings, wireless settings, and wireless network settings★.

U disk management: Download User List, Upload User List, Download Cashier Record, Upgrade Firmware, Upgrade Parameters.

System settings: Machine Time Settings, Restore Exit Settings, Whitelist Checking, Operator Card Checking, Machine Type (Consumer/Cashier/Subsidy Machine), Machine Password, Administrator Settings, Voice Tips, Volume Size.

Cashier management: Relevant settings and queries for cashiers, such as data queries (recharge queries, recharge statistics); set fixed value, preferential ratio and cashier type (recharge, refund).

Data query (Only horizontal type 60): Recharge query and recharge statistics.

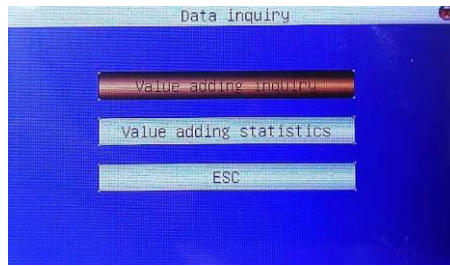

System information: View the number of users' registration numbers, the number of cashier records, and the device information

In addition to the cashier management options, U-disk management and system information are slightly different, but the use of the same, other options menu functions are also the same as the consumer, please refer to the above consumer function introduction, not detailed here.

In the main menu of the cashier, press ▲/▼/◀/▶ key to the cashier management options, press the [Confirm] key to enter the cashier management sub-menu window:

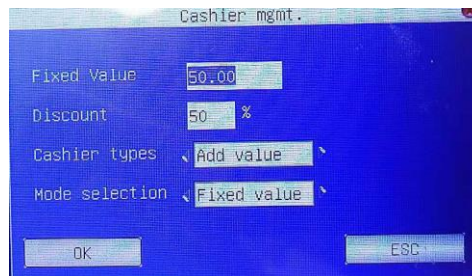

- **Fixed amount**

Set the amount of recharge, the unit is "Yuan". The fixed amount is only available when the teller type is selected as a recharge. Press the numeric key to enter the amount of recharge. After setting up, press the [Confirm] key to save the exit, or press the [Cancel] key to not save the exit editing status ◦

- **Preferential ratio**

When the teller type is a recharge mode, the discount ratio can only be used. After the preferential ratio is set, when the card is swiped, the actual charge amount is (fixed value or input amount)* preferential ratio ◦

Press the number key to enter the discount rate, the range is from 0 to 100. After setting up, press the [Confirm] key to save the exit, or press the [Cancel] key to not save the exit editing status ◦

- **Cashier type**

The types of cashier include recharge and refund. If "recharge" is selected, the amount will be charged when the card is swiped; if "refund" is selected, the amount will be withdrawn from the card when the card is swiped. After selecting, press [confirm] button to save or exit, or press [cancel].

(**Note:** When the cashier type is set to "recharge", press the [query) key to enter the data query window, where recharge query and recharge statistics can be performed; otherwise, when the cashier type is set to "refund"; in the data query window, the refund query and statistics can be performed.)

- **Mode selection**

There are two modes to choose from: fixed value mode and amount mode

When the "fixed value mode" is chosen, the amount of charge/refund when the card is swiped is the fixed value set in the cashier management.

When the "amount mode" is selected, the amount of charge/refund when the card is swiped is the amount entered by the administrator or operator on the administrator's keyboard.

If a value is set in the preferential ratio, the actual charge/refund amount becomes the preferential ratio.

2.2.2 Cashier management

2.2.2.1 Recharge query

In the main menu window of the cashier, press ◀/▶ key to the data query options, press the [Confirm] key to enter the data query window, in the ▲/▼ key to the recharge query options, press the [Confirm] key to enter the consumption details query window:
Press the confirmation button to enter the detail query window.

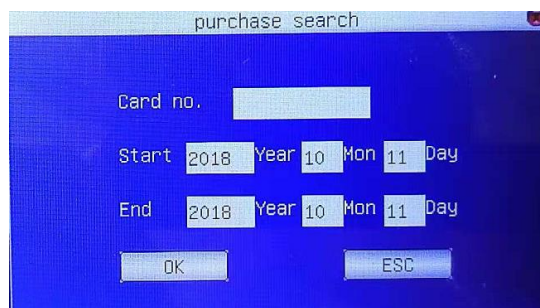



The screenshot shows a window titled "purchase search" with a blue background. It contains the following fields and buttons:

- Card no. []
- Start 2018 Year 10 Mon 11 Day
- End 2018 Year 10 Mon 11 Day
- OK []
- ESC []

When the card number, start and end time are set, press the [Confirm] key to query the recharge record corresponding to the card number within the specified time.

2.2.2.2 Recharge statistics

In the main menu window of the cashier, press  key to the data query options, press the [Confirm] key to enter the data query window, in the  key to the recharge statistics options, press the [Confirm] key to enter the cashier statistics window:

Press the confirmation button to enter the detail

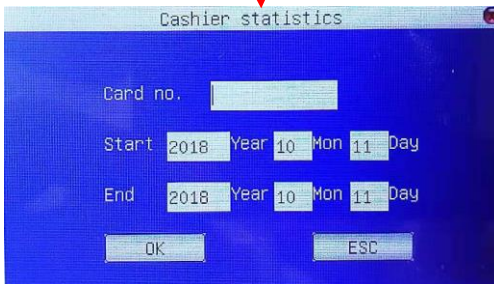

When the card number, start and end time are set, press the [Confirm] key to query the cashier record corresponding to the card number within the specified time:

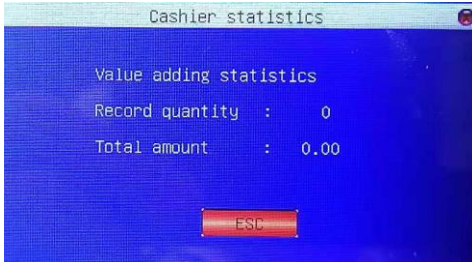

 **Note:** Here take the recharge query and the recharge statistics as an example to introduce the operation method of the recharge query and the recharge statistics; the operation method of the refund query and the refund statistics, similar to them, will not be repeated here.

2.3 Function of subsidy machine

2.3.1 Main menu of subsidy machine

When the machine type is a subsidy machine, in normal mode, press the [menu] button to enter the main menu of the subsidy machine.



Communication settings: Network settings, serial port settings, connection settings, wireless settings and wireless network settings.

U disk management: Download user list, upload user list, download subsidy record, U-disk upgrade firmware, U-disk upgrade parameters.

System setting: Machine Time Settings, Restore Exit Settings, White List Checks, Operator Card Checks, Machine Type (Consumer/Cashier/Subsidy Machine), Machine Password, Voice Tips, Volume Size.

Subsidy management: Data query (subsidy details, subsidy statistics), set up whether cumulative subsidy, zero subsidy and confirm the key subsidy.

Data checking(Only horizontal type 60): Subsidy details and subsidy statistics.

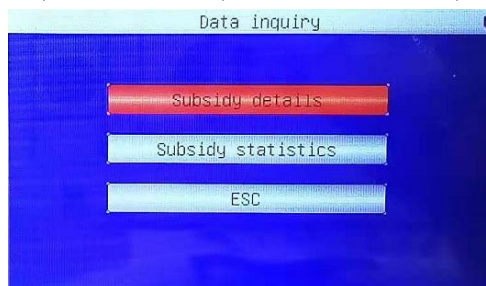

System information: Check the number of users, records of management, records of subsidies, and equipment information.

In addition to the subsidy management options, U-disk management and system information are slightly different, but the use of the same, other options menu functions are also the same as the consumer, please refer to the above consumer function, no more detailed here.

2.3.2 Subsidy management

In the main menu of the subsidy machine, press ▲/▼/◀/▶ key to the subsidy management options, press the [Confirm] key to enter the subsidy management sub-menu window.

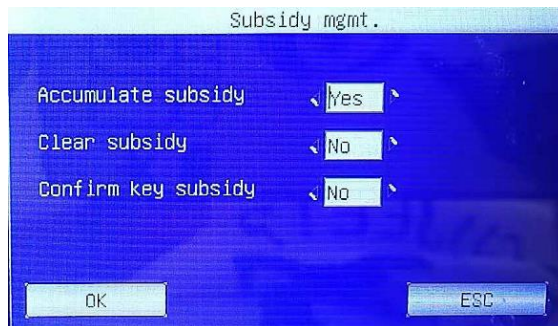

- **Cumulative subsidy**

When the cumulative subsidy is "yes" and the cardholder swipes the card, the machine will automatically add the amount of the subsidy to the card, and the amount of the card will increase.

When the selection is complete, press the [Confirm] key to save the exit, or press the [Cancel] key to not save and exit the edit state.

- **Clear subsidy**

When the zero-clearing subsidy is "yes" and the cardholder swipes the card, the machine first clears the balance in the card, and then fills the subsidy into the card.

When the selection is complete, press the [Confirm] key to save the exit, or press the [Cancel] key to not save and exit the edit state.

- **Press confirm key subsidy**

When the confirmation key is pressed to subsidize the choice of "Yes" and the cardholder swipes the card, the machine will prompt "Please press the [confirm] key !". The credit card holder must press the [confirm] button before filling the card into the card.

When the selection is complete, press the [Confirm] key to save the exit, or press the [Cancel] key to not save and exit the edit state.

2.3.2.1 Subsidy details enquiry

In the main menu window of the subsidy machine, press the ◀/▶ button to the data inquiry option, press the [Confirm] key to enter the data inquiry window, press the ▲/▼ key to the subsidy details option, press the [Confirm] key to enter the consumption details inquiry window:

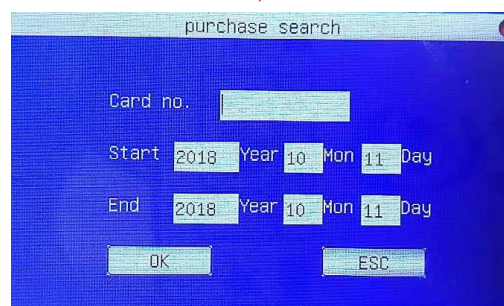

When the card number, start and end time are set, press the [Confirm] key to query the subsidy record corresponding to the card number within the specified time

2.3.2.2 Subsidy statistics

In the main menu window of the subsidy machine, press ◀/▶ key to the data query options, press the [Confirm] key to enter the data query window, in the /key to the subsidy statistics options, press the [Confirm] key to enter the subsidy statistics window:
Press the confirmation button to enter the detail query window:

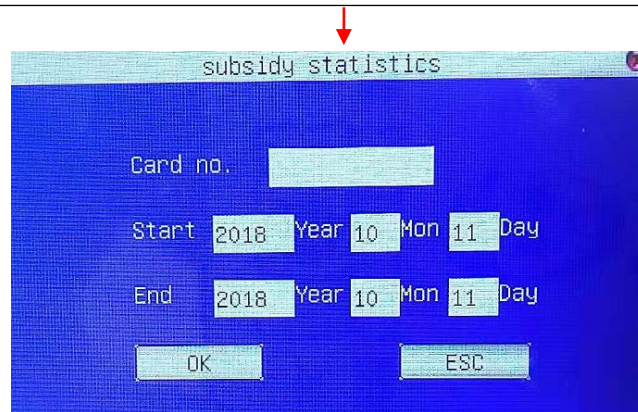

When the card number, start time and end time are set, press the [Confirm] button to query the subsidy statistics which are corresponding to the card number within the specified time.

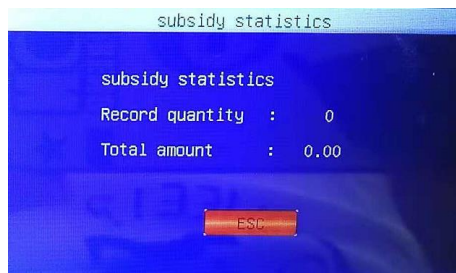

2.4 Consumer operation panel

When consumers need to inquire about consumption records, press the "inquiry" button in the user interface to enter the consumer inquiry interface, specific operations see the details of the consumption inquiry.

When a consumer needs to report loss, amount, or modify a password on a card, press the [Function] button in the Consumer Action Panel to display the following menu:



Report the lost: Enter the card number and password to report the loss of the card number. ◦

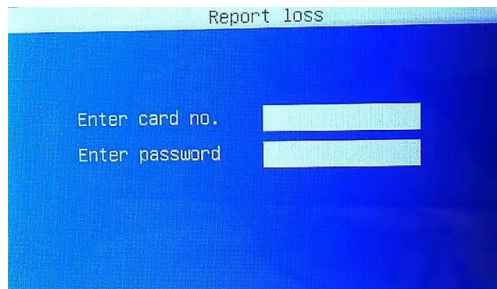

Cancel the lost report: Enter the card number and password to solve the card number.



Change the password: Modify the password for excess consumption of card number.

After "password modification" is selected, prompt "please swipe card", pictures shows below:



After the credit card, enter the old password and the new password as required below. After typing the old and new password, press [confirm] button to change the password successfully. If the password is successfully modified, the

password will be prompted to change successfully, otherwise the password will be changed again.



Note: Only when the consumer software on the server is connected by TCP / IP on-line can the loss, detachment, and encryption be effective on the machine.

3 Operation process of consumption machine

3.1 Promotion of credit card

When credit the card, the device will give different judgment flow according to the current machine type, and display relevant information on the main screen according to the judgment result, prompting the user to proceed with the next operation.

Credit card					
Comparison between main sector and backup Sector (correct it when different)					
Distinguish between management card and consumption card					
Blacklist checking					
Whitelist checking					
Consumption machine			Recharge machine		Subsidy machine
Amount consumption	Timed consumption				
Judge of eating time	Judge of card valid use period		If the amount larger than 0		Judge of card valid use period
Discount calculation	Import and export judgment		Judge of card valid use period		Is there a subsidy record?
Judge of card valid use period	Import	Export	Recharge	refund	Is it subsidized?
Maximum limit of meal limit		Time consumption	Preferential recharge		Clear the subsidy or not
		Discount calculation	Judge of storage space		Judge of storage space
minimum, maximum limit of card balance		largest consumption of every time	Write card		Write card
Judge of maximum consumption per time		Maximum limit of daily limit	Save record		Save record
Maximum daily limit		Excess consumption verification	Display information		Display information
Excess consumption verification		Minimum and maximum balance			
Judge of balance		Judge of balance			
Is accounting judgment used?		Is accounting judgment used?			
Judge of storage space		Judge of storage space			
Write card		Write card			
Save record		Save record			
Display information		Display information			

Notes and explanations:

Blacklist: The missing card will be blacklisted.

Notes and explanations: Automatic blacklist checking system.

Whitelist: The system automatically blacklists the cards which can be found in the user data and used normally are white-list cards.

Explanation of notes: Enable whitelist check.

Not in the consumption period: The current time is not defined in the consumption period.

Explanation of notes: No consumption period was detected when the card was not set up.

- When the card set up the batch, the batch time consumption was tested.
- The machine does not set up the consumption time period, and needs to be set up in the machine consumption management.

No meal type in system: No meal type set in machine.

Explanation of notes:

- 1 - When there are available meal, the maximum meal limit and the maximum meal set, meal type is required to be checked.
- 2 - No meal settings were downloaded to the machine.

Excess balance: The balance exceeds the set range.

Explanation of notes: The card balance is larger than the maximum card balance set by the card type or less than the minimum card balance set by the card type.

Excess consumption: Consumption amount exceeds the specified amount.

Explanation of notes: The amount or frequency of consumption is greater than the maximum limit or maximum daily limit.

Past validity period: The card has past the effectively used period.

Explanation of notes: effectively used period of card. (Setting of card type)

No consumption authority of this machine: This card is not available in this machine.

Explanation of notes: The card type has set up the available machine, and the local machine is not available.

Card type not exist: no setting information of this card type in this machine.

Explanation of notes: The card information is set up in the machine, but can not find.



Note: If the machine does not have any card information, the card type is not detected, and no judge make of corresponding card information.

No consumption authority of this meal type: No consumption allowed in current meal type.

Explanation of notes: The available meal type is set in the card type, but check that the current meal is not available.

No meal type in the system: No meal type set in the machine.

Explanation of notes:

- 1 - The card set up the available meal type, and the meal type must be judged, but there is no setting in the system then need to be prompted in the system.
- 2 - The maximum number of meals or the maximum amount of meals is set by the card type, then must judge the type of meals, but there is no set type of meals then need to be prompted in the system.

Different card number: Credit card is different after deduction of payment.

Explanation of notes: When the deduction fails, the card number is not the previous card when the deduction is re-deducted. This prevents the last card balance from being written into another card. ◦

Operator locked: Operator (administrator) lock the machine ◦

Explanation of notes: Operator checks are set up, and there are registration operators (administrators) in the machine. It is necessary for the operator (administrator) to swipe the card before carrying out the operation of the machine.

In the process of machine operation, swipe card can lock the machine. When the machine is locked, the operator administrator can unlock it. This is used to operate the consumption statistics.

No such commodity: No exist of this commodity.

Explanation of notes: Commodity consumption mode does not exist when the commodity ID number is entered, or barcode input does not exist.

Restart to take effect: The machine needs to be restarted before setting up.

Explanation of notes: After setting up fingerprint verification. It is necessary to restart the machine to initialize the fingerprint to identify the fingerprint.

Consumption hours are zero: The consumption period is zero.

Explanation of notes: During time consumption, the difference between outgoing time and entry time is less than 0.

Card usage exceeded: Cards used more than 65535 times.

Explanation of notes: Cards used more than 65535 times. That means the more than 65534 cards consumed on this machine. It is impossible to use such a high frequency in actual use.

3.2 Design of main process

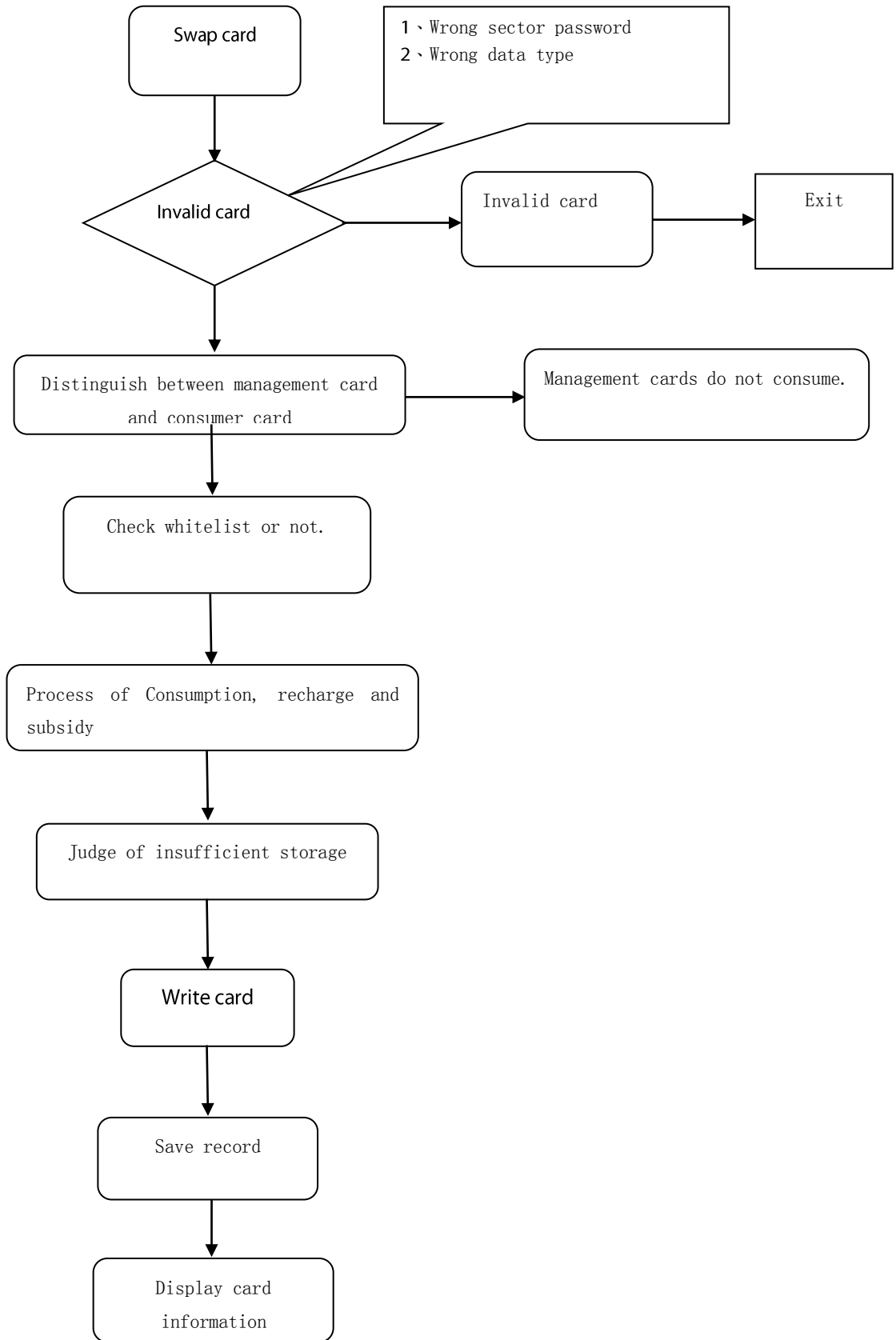

Note: Blacklist is default to be checked in current consumption system.

3.3 Design of consumption machine process

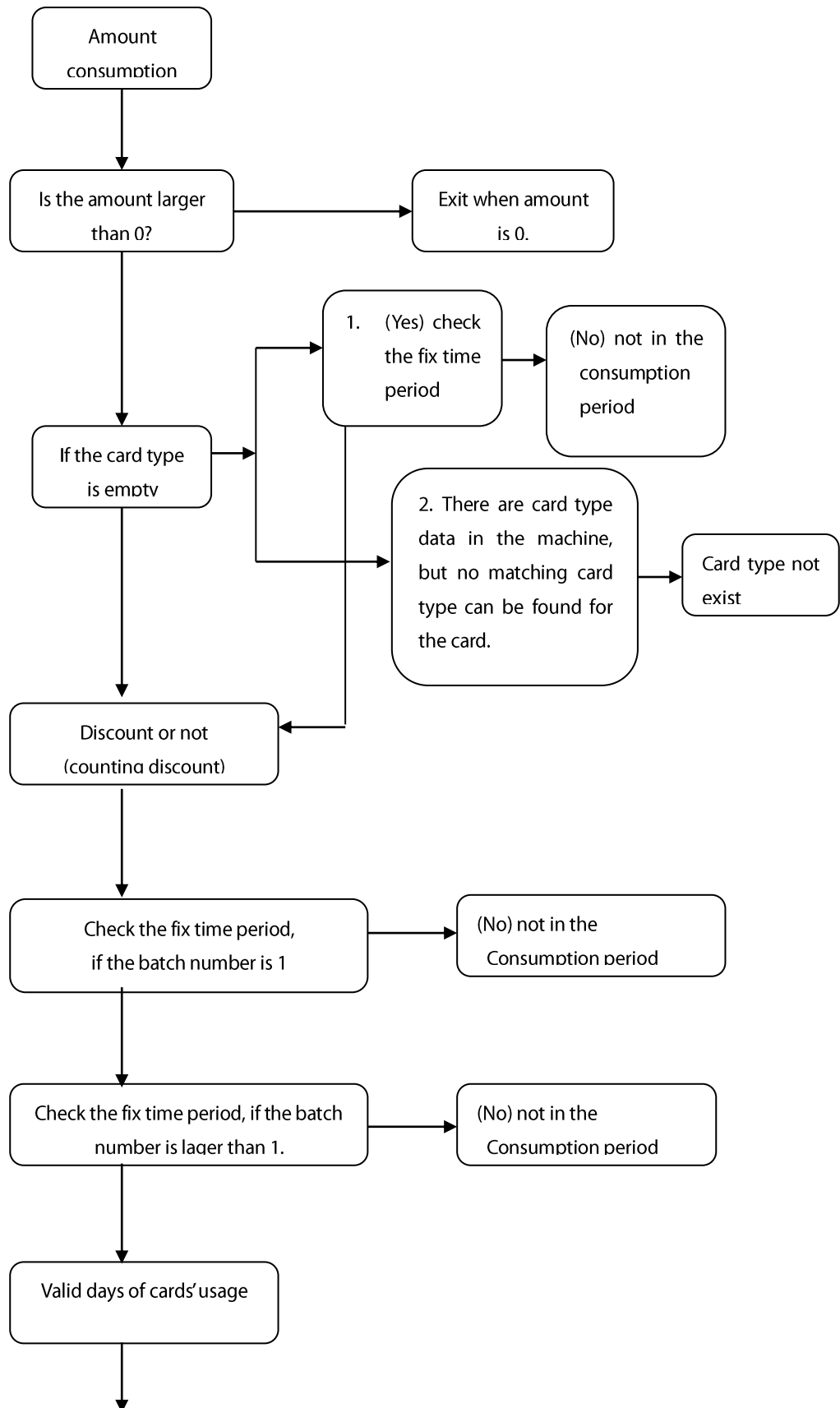

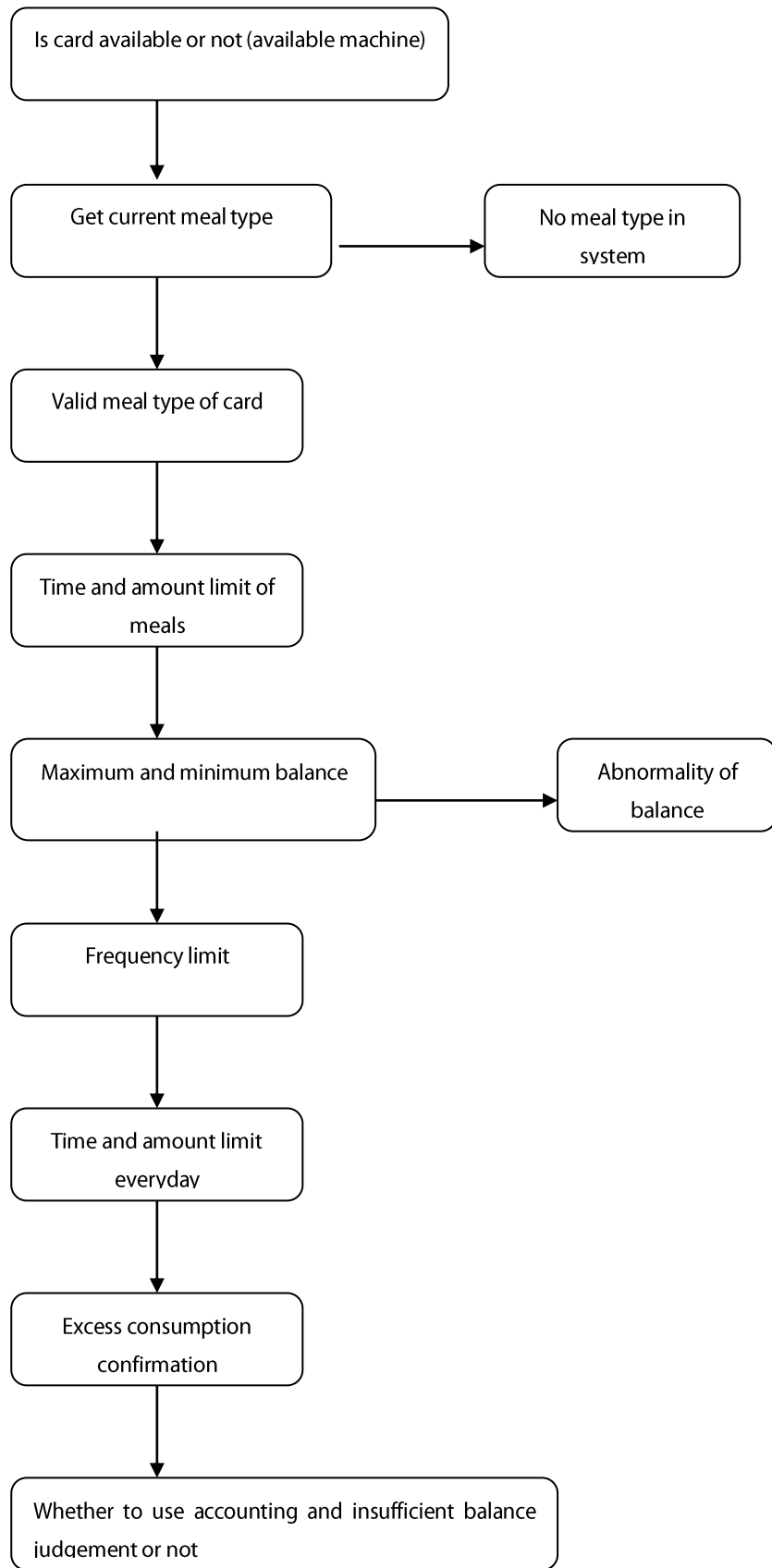

3.4 Process of frequency calculation

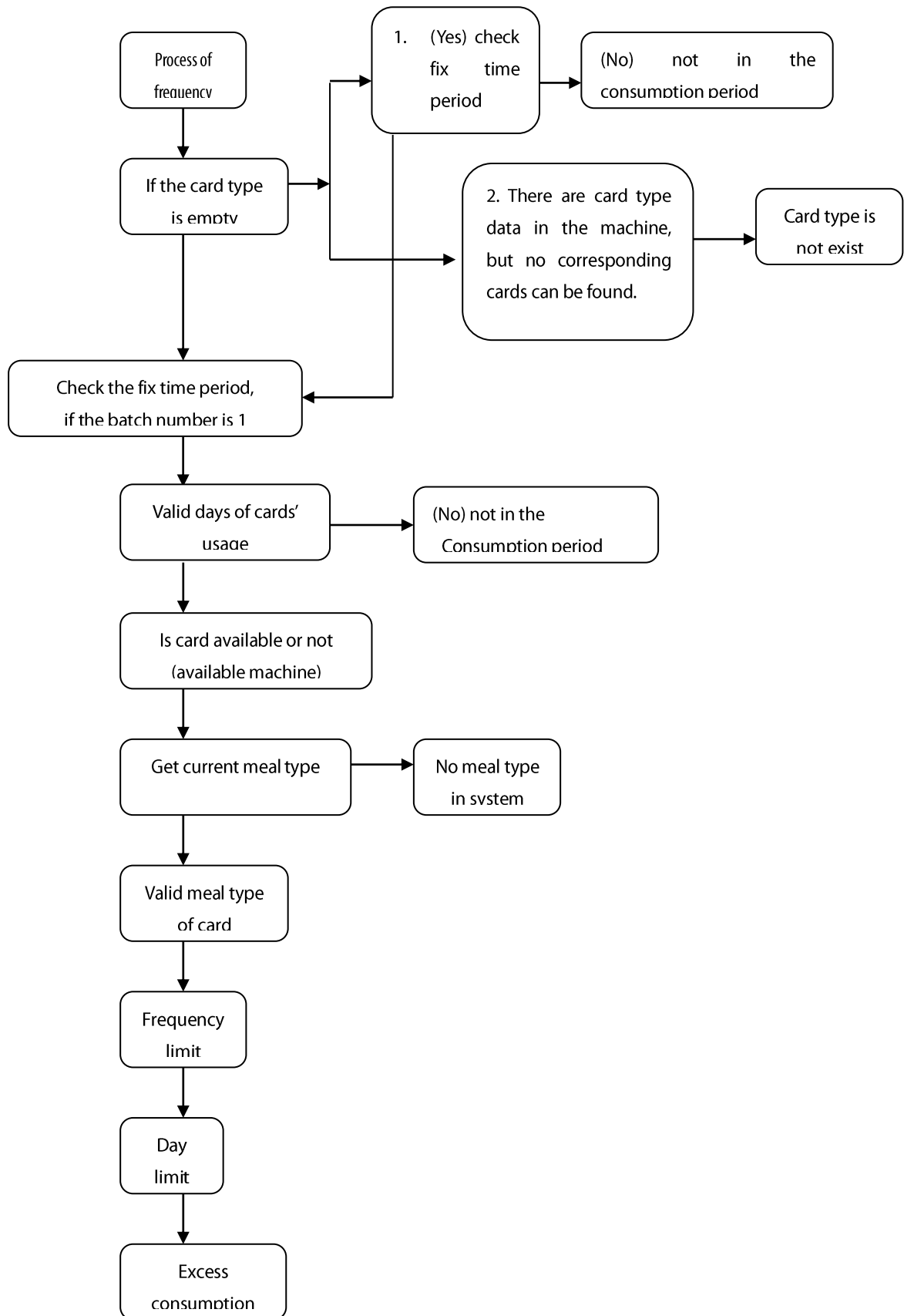

3.5 Timing process

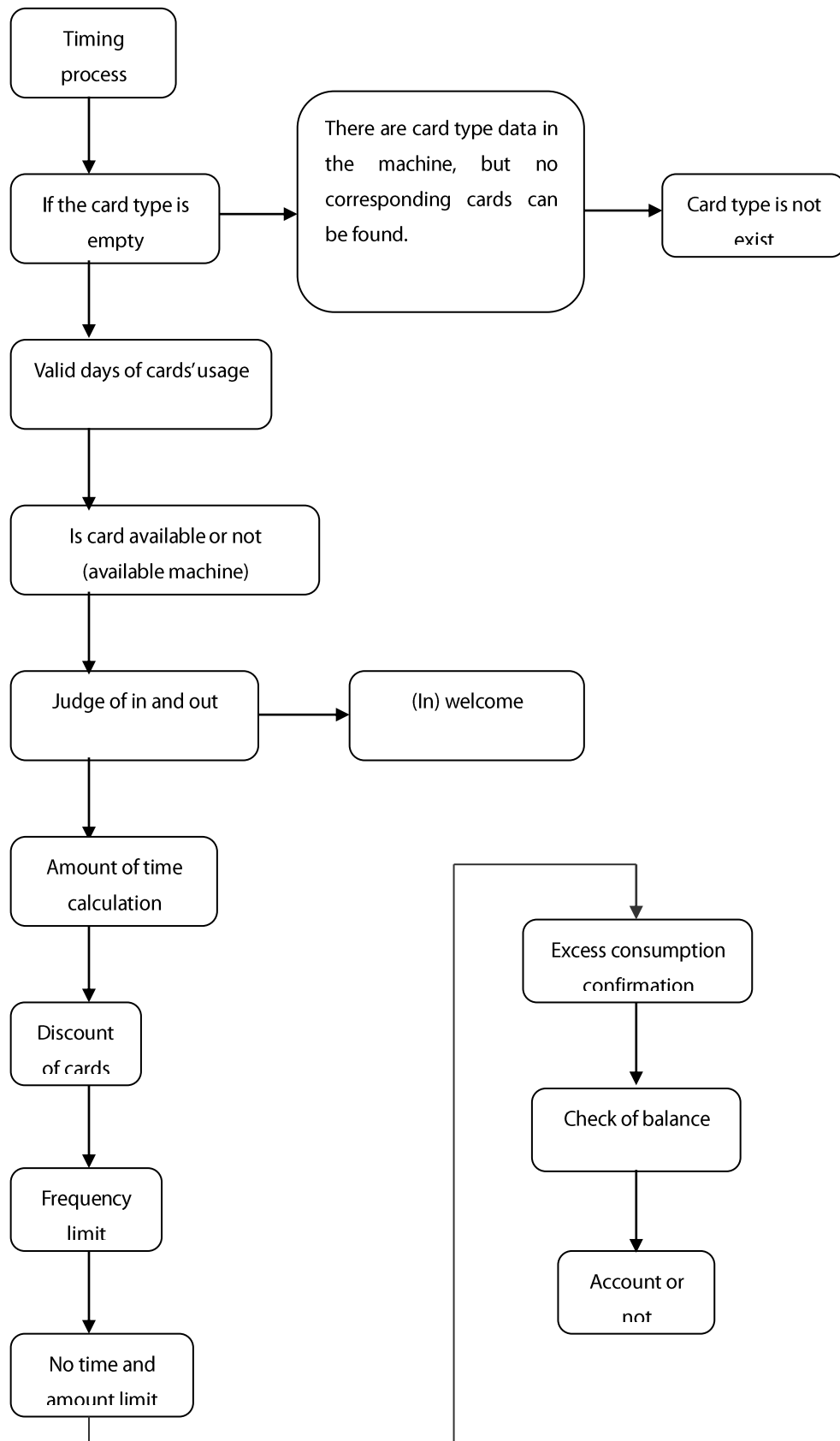

3.6 Process of recharging machine

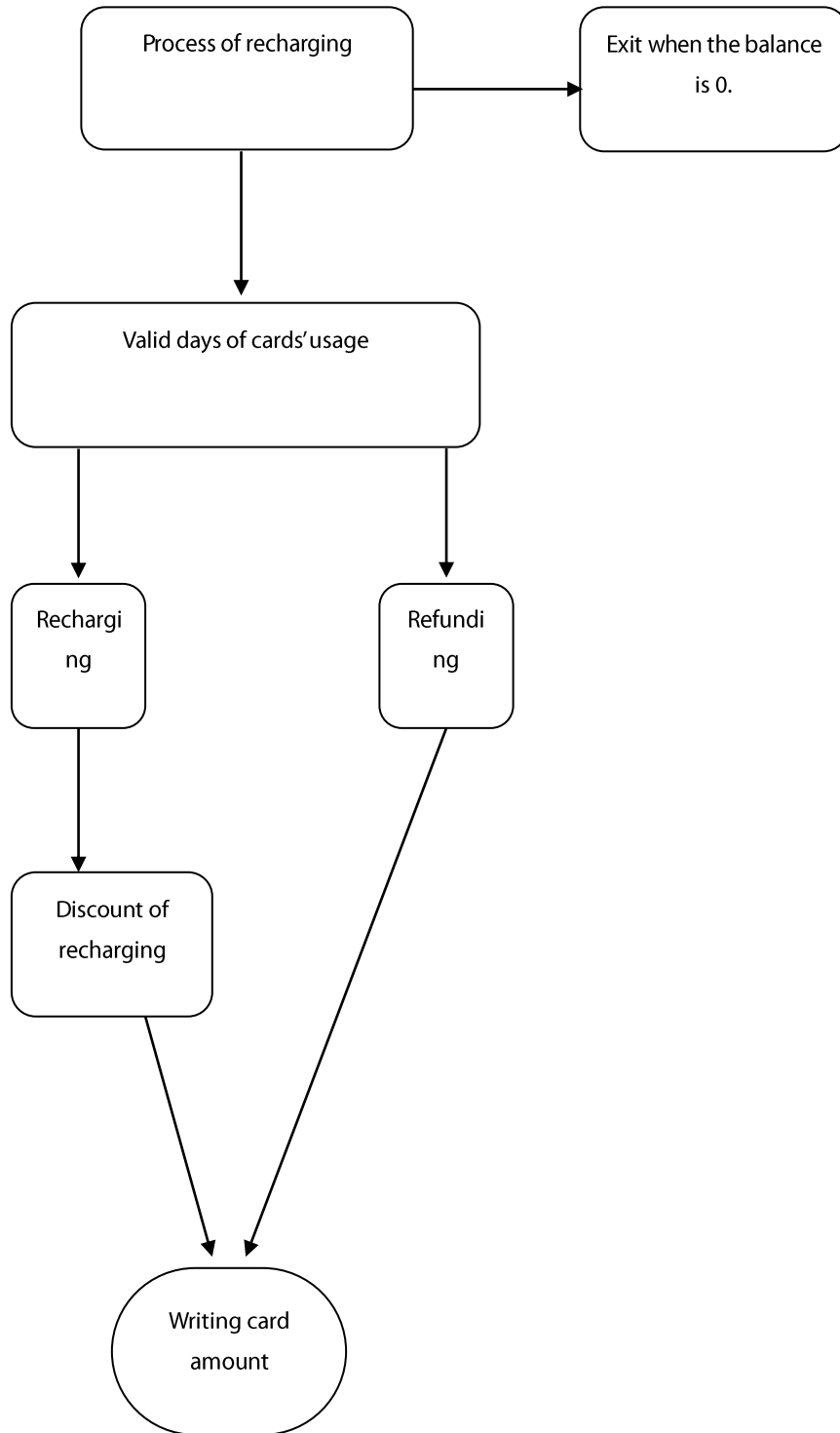

3.7 Process of subsidy machine

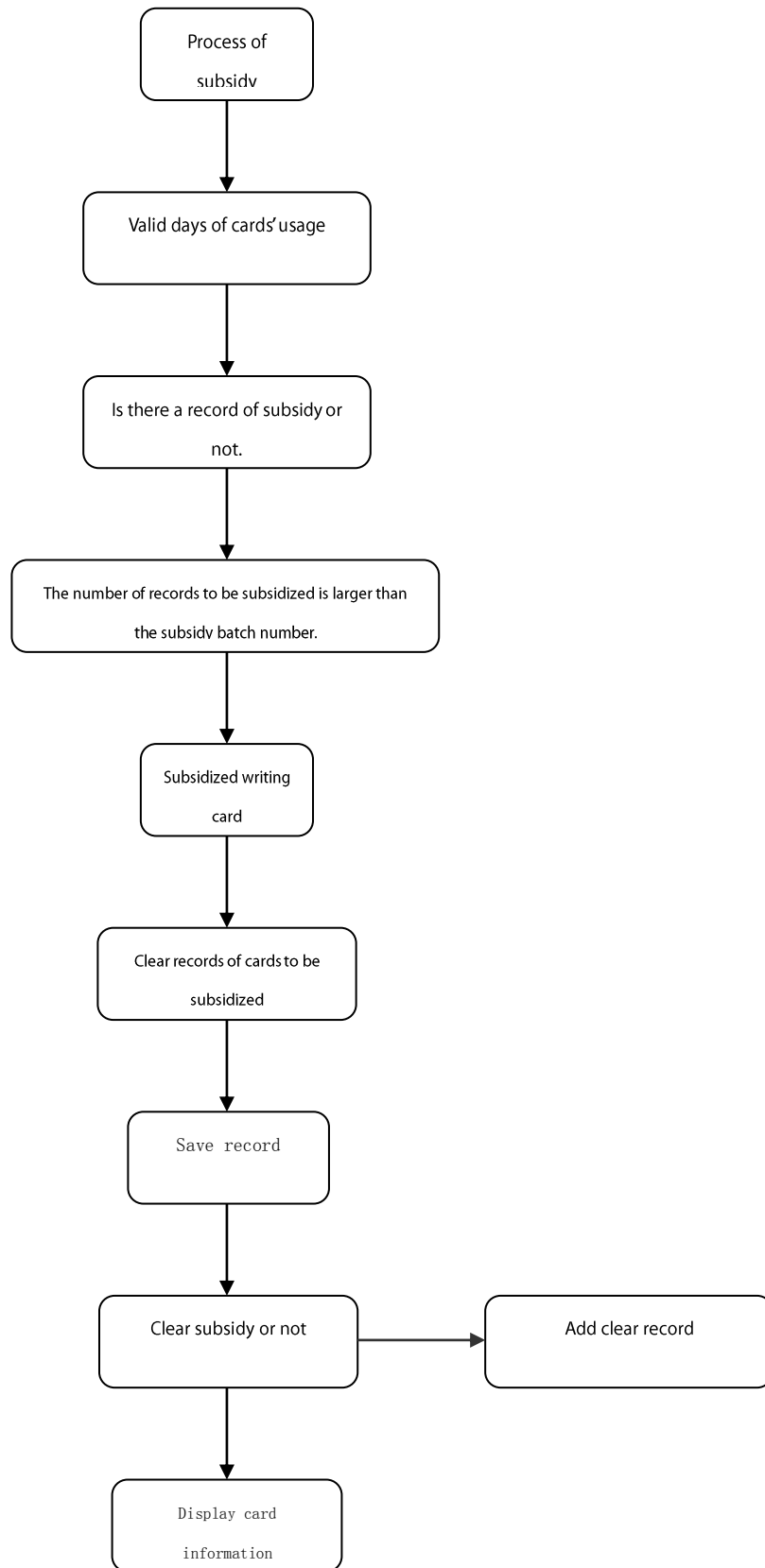

Appendix T9 Typewriting★

T9 typewriting is also named intelligent typewriting. It is famous for its efficient and fast input of characters. This device supports the input of T9 English and symbols. T9 English has three or four English letters on the numeric key of machine 0~9, for example, there are three letters A, B and C on the numeric key 2, T9 only needs to enter the key where the letter is located once. The screen will display all letters on this key, press▲/▼ to locate on the letters to be chosen. With the help of T9 typewriting, users can input network identification names, etc. T9 typewriting can also input some symbols.

For example, in WI-FI setting, enter the operation of network identification ID:

Press [· /▶] key enter the English typing status of T9 typewriting, and then type "dlink".

Enter the "3" numeric key of the "dlink" first letter D, then press the 0 key to select "d" according to the interface prompt. The selected letters will appear in the input box.

Continue typing other letters in the data key "5465", select lowercase letters. If the input is incorrect, press ◀ key to cancel it. After entering letters, press the [confirm] button to confirm the current input.

The words you want to input will be displayed. If you want to continue, you can input them again. When the input is completed, press [cancel] to exit.

ZK Building, Wuhe Road, Gangtou, Bantian, Buji Town,
Longgang District, Shenzhen China 518129

Tel: +86 755-89602345

Fax: +86 755-89602394

www.zkteco.com

